

# RADIO

ESTABLISHED 1917

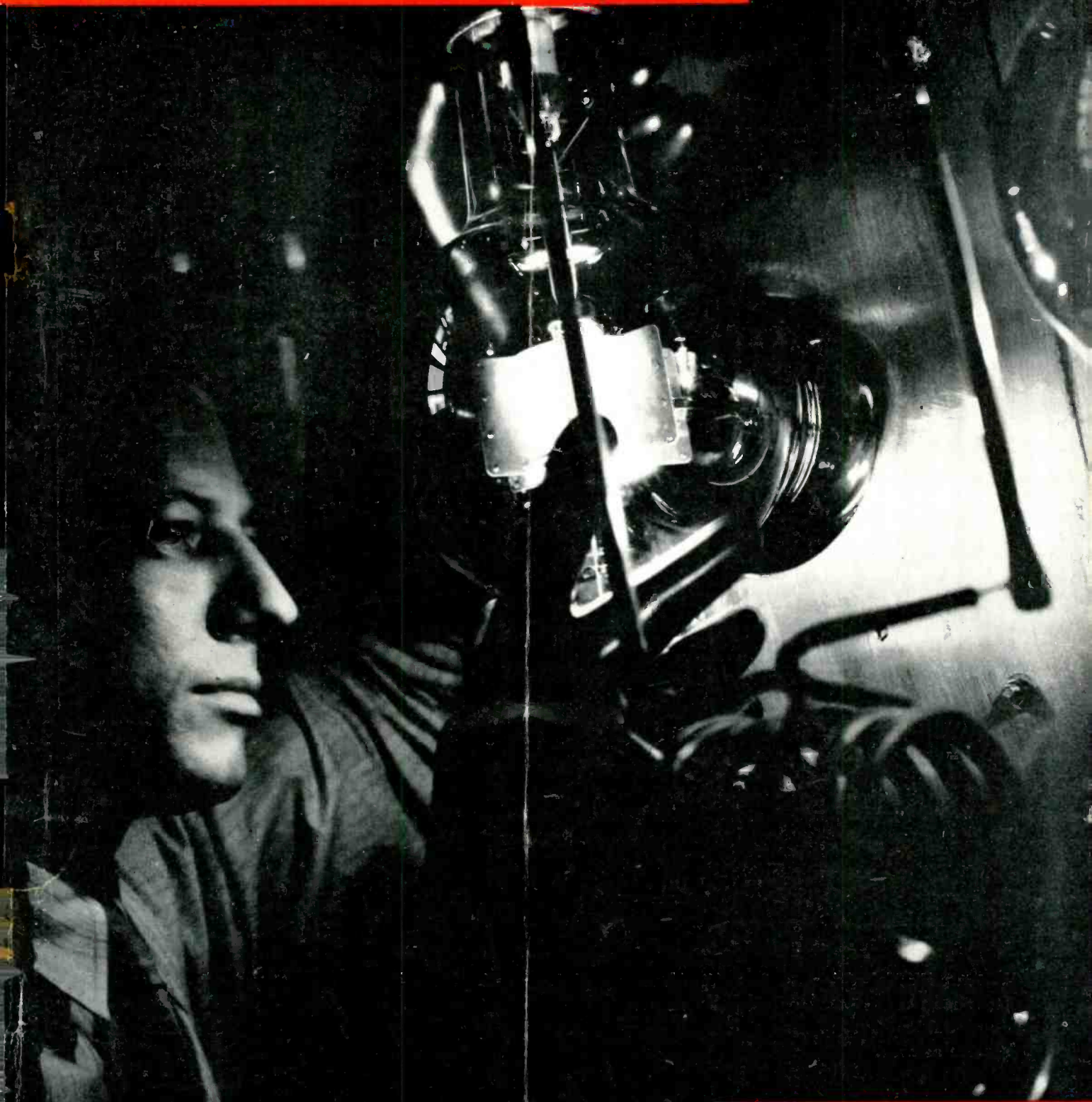

**RADIO-ELECTRONIC**

Design • Production • Operation

**AUGUST, 1943**





ANDREW  
BENSEN

# OLD FRIENDS INSPIRE Confidence



The former radio serviceman now in the Army Signal Corps or Navy Communications knows from peacetime experience that he can depend on Raytheon tubes. When he uses Raytheons for installations and replacements he knows they will stand by him when the going is toughest—like a trusted friend.

The reason the Raytheon trademark is seen so frequently in the armed forces is the same reason it was so widely used and respected by the serviceman in peacetime.

When peace is won, and the serviceman is back in his shop, Raytheon tubes will be giving the same dependable and efficient service as ever.



**Four "E" Awards**  
Each division of Raytheon has been awarded the Army & Navy "E."

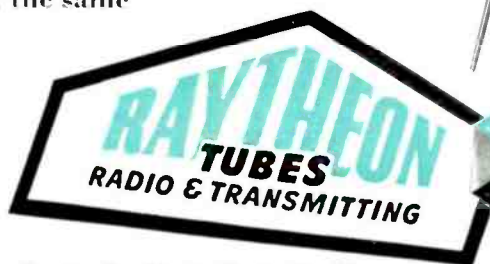

**RAYTHEON PRODUCTION CORPORATION**  
NEWTON, MASS. • LOS ANGELES • NEW YORK • CHICAGO • ATLANTA  
DEVOTED TO RESEARCH AND THE MANUFACTURE OF TUBES FOR THE NEW ERA OF ELECTRONICS



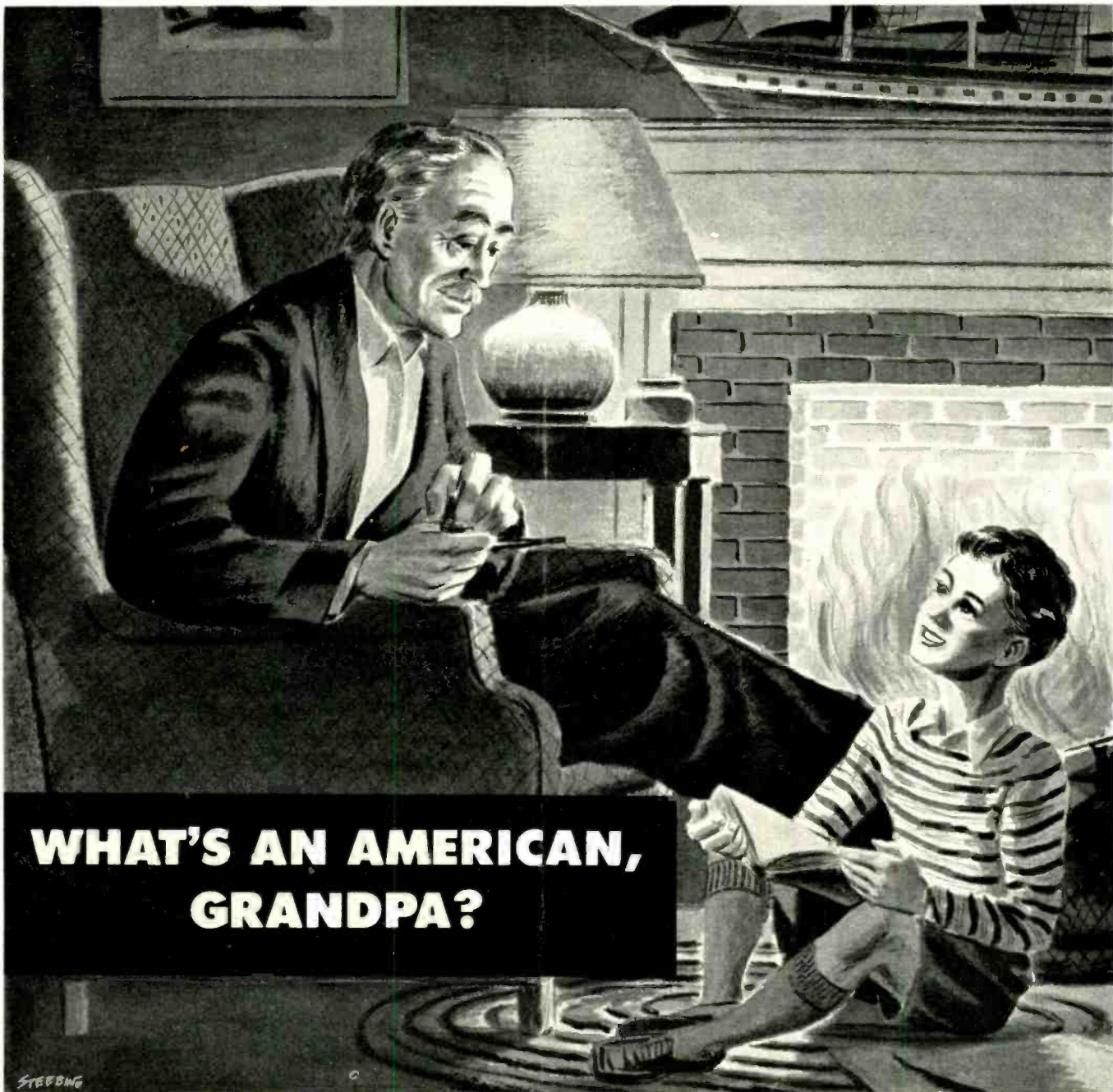

## WHAT'S AN AMERICAN, GRANDPA?

**S**on, it's a little hard to describe an American! Maybe I had better start by saying he is a peaceful fellow, hates to start anything that he thinks will hurt his fellow man. Some folks think he is slow-starting,

well, maybe so, but once he gets started he can produce faster than anyone, especially those who threaten the peace and security of his home or his liberty to go and come or do what he wants to do.

Son, an American is the fightin'est fellow I know of when you threaten him with the loss of any one of the real American principles.

BUY MORE BONDS!    
**hallicrafters**  
 CHICAGO, U. S. A.





# SCR-299

## VANGUARD OF INVASION!



THE SCR-299 Mobile Radio Communications unit played a great part in the invasion of Africa and Sicily . . . these units were used as mobile radio stations, transmitting voice commands to fast moving armored units while in action, or as permanent radio stations . . . even under the most difficult operating conditions.

A leading military authority said, "My observations in the theatres of war make it possible to say that the SCR-299 hit the jack pot in the mobile radio field as has the jeep in transportation."

BUY  
MORE  
BONDS!



# the hallicrafters co.

CHICAGO, U. S. A.

THE WORLD'S LARGEST EXCLUSIVE MANUFACTURER OF SHORT WAVE RADIO COMMUNICATIONS EQUIPMENT



# CRYSTALS IN THE MAKING

AS DIAGRAMMED BY CRYSTAL PRODUCTS

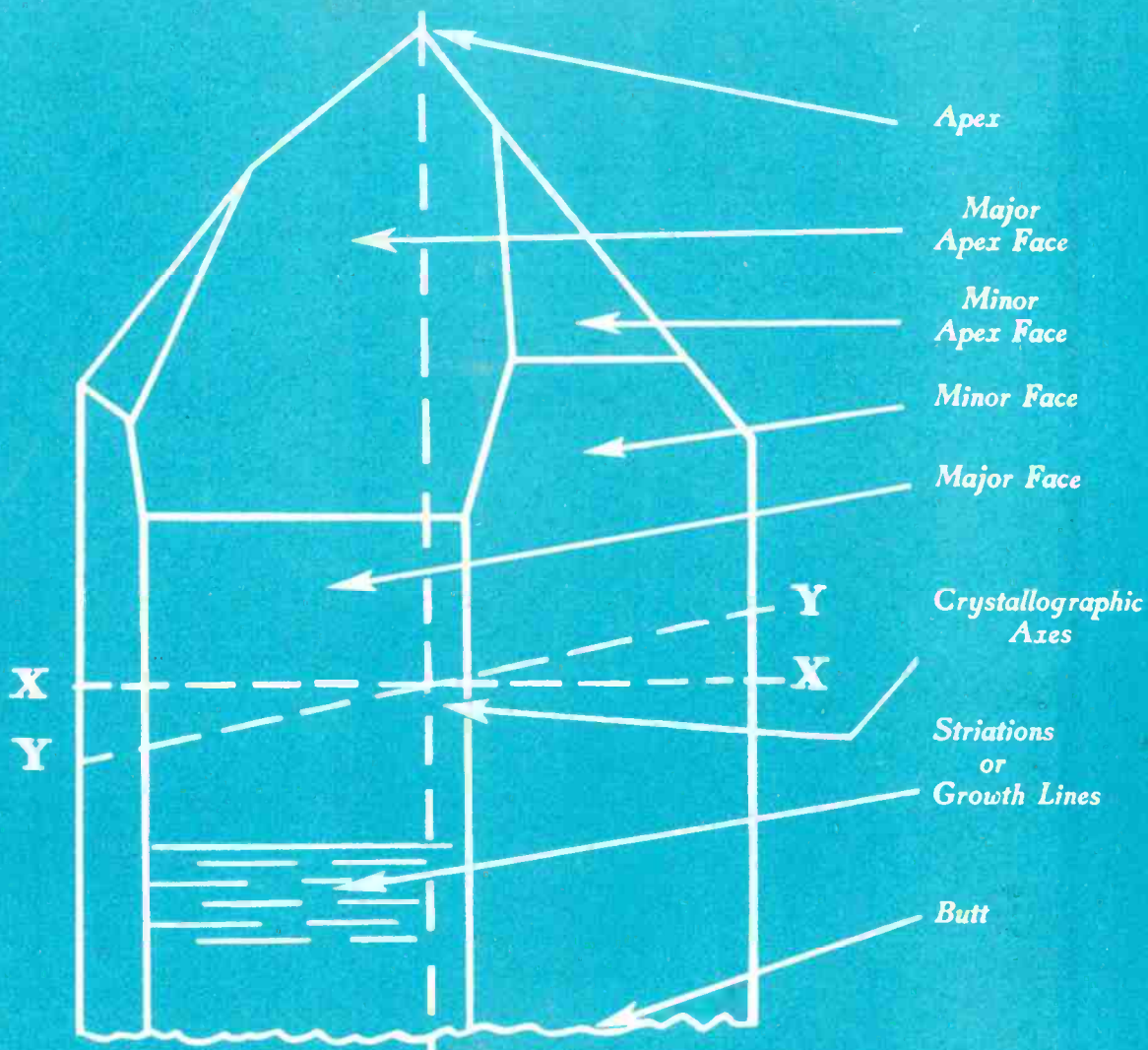

After being expertly inspected for impurities and the direction of cut determined . . . each of these painstaking operations must be absolutely accurate . . . the crystal is mounted for sawing. For precision crystals the mother is mounted with the optic axis running parallel to the plate and the electric axis perpendicular

to it. This operation can become exceedingly difficult with a lack of an apex and well-defined faces.

When neither faces nor apex are present, the axis must be located by another method before it can be mounted for cutting.

Precision cutting is an all important factor in the production of crystals for radio frequency control.

 *Crystal*

PRODUCTS COMPANY  
1519 MCGEE STREET, KANSAS CITY, MO.

*Producers of Approved Precision Crystals for Radio Frequency Control*

# RADIO

Published by RADIO MAGAZINES, INC.

## Editor

M. L. MUHLEMAN

## Business Staff

M. L. Muhleman, Publisher  
and President

S. R. Cowan, Business Manager  
and Treasurer

R. Weiss, Advertising Production

R. Alan, Circulation Manager

CORRESPONDENCE and ORDERS should be sent only to our New York office. MANUSCRIPTS, if unsolicited and unusable, will not be returned unless accompanied by a stamped, self-addressed envelope.

EXECUTIVE, editorial, and advertising offices of Radio Magazines, Inc., are located at 132 West 43rd Street, New York, 18, N. Y., to which address all correspondence, advertising copy and cuts should be directed.

SUBSCRIPTION RATES (in U. S. funds): Two years, \$5.00, or \$3.00 yearly in U.S.A. To Canada and all foreign countries, \$4.00 yearly. Twelve issues yearly; back issues are not included in subscriptions.

NOTE: Because of wartime censorship restrictions, we must reserve the right to withhold from foreign subscribers any issue the regular domestic edition of which is not approved by the authorities for export without changes. In such cases subscriptions will be extended so that each subscriber will eventually receive the number of issues to which he is entitled.

IF YOU MOVE, notify us in advance; we cannot replace copies sent to your old address. Notice must be received by the 20th of the month preceding the cover date of first issue to go to the new address.

AUGUST 1943

No. 283

## Table of Contents

### COVER

A radio-electronic tube furthering the war effort. This one is working at ultra-high frequencies. Photo courtesy Westinghouse Electric & Mfg. Co.

### ARTICLES

- Poynting's Vector in Wave Guide and Radiation Phenomena—*V. J. Young* 23
- Some Suggestions for Standards of Good Operating Practice in Broadcasting—*Harold E. Ennis*..... 27
- Volume Expansion by Negative Definition—*G. E. Otis*..... 30
- Radio Weather Forecasting—*Pvt. Perry Ferrell, Jr.*..... 32
- Characteristics of Radio-Electronic Components, Part 3—*A. C. Matthews* 36
- Radio Design Worksheet: No. 16—Optical Path; Phase-Modulated Wave 39
- Q & A Study Guide: A.F. Amplification, Part 4—*C. Radius*..... 41
- Radio Bibliography: 12—Television: Section 1, Part 1—*F. X. Rettenmeyer* 43

### MISCELLANEOUS

- Editorial ..... 8
- Technicana ..... 12
- This Month ..... 52
- New Products ..... 54
- Advertising Index ..... 66

RADIO (title registered U. S. Pat. Off.) is published monthly at 34 N. Crystal Street, East Stroudsburg, Pa., by Radio Magazines, Inc., Executive and Editorial Offices at 132 West 43d Street, New York 18, N. Y. Subscription rates—United States and Possessions, \$3.00 for 1 year, \$5.00 for 2 years; elsewhere \$4.00 per year. Single copies 35c. Printed in U.S.A. All rights reserved, entire contents Copyright 1943 by Radio Magazines, Inc. Entered as Second Class Matter October 31, 1942, at the Post Office at East Stroudsburg, Pa., under the Act of March 3, 1879.



We're... **"ALL WORK TO WIN THE WAR!"**  
 ENLISTED BEFORE PEARL HARBOR  
 ... EVERY DIVISION IN THE  
 "GUTHMAN ARMY"

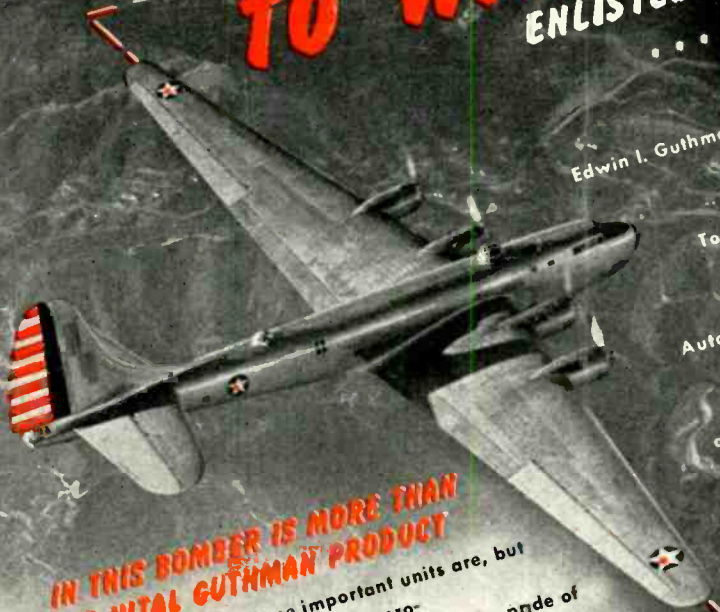

**IN THIS BOMBER IS MORE THAN ONE VITAL GUTHMAN PRODUCT**

We can not tell what these important units are, but we are working hard so that these products can keep up essential communications. The pride of being selected for such war time tasks is reflected in the skilled efforts of our 700 employees. Guthman-made radio units are being supplied for tank, plane, and command car transmitters and receivers, and other army and navy signal corps equipment. Housed in our 60,000 square foot building is one of the most modern radio, electrical and chemical laboratories. Our plant is 100% concrete and brick, completely sprinkler-equipped.

Edwin I. Guthman & Co. and our affiliated Lincoln Machine and Tool Corporation were converted to 100% war production prior to Pearl Harbor:  
 Tool & Die Division ... Machine Division (Production Milling Machines, Lathes, etc.) ... Punch Press Division (Presses up to 150 tons) ... Automatic Screw Machine Division (00G - 2G B. & S. Machines) ... ZincShield Can Fabrication (In affiliation with Hegeler Zinc Co.) ... RF, IF and Choke Coil Division ... Condenser Division (Special Molded Paper and Mica, and Trimmings: Condensers) ... Wire Insulation Division (Litzendraht and Textile Covered Magnet Wire) ... Electro-Plating and Finishing Division (with completely Modern Mechanical Conveyors and Barrels) ... General Assembly Division of Complete Units incorporating the above items such as complete RF Tuning Assemblies, Intercommunication Units, etc.



**EDWIN I. GUTHMAN & CO., INC.**

15 SOUTH THROOP STREET ★ CHICAGO

PRECISION MANUFACTURERS AND ENGINEERS OF RADIO AND ELECTRICAL EQUIPMENT

# EDITORIAL

## TELEVISION

★ Ralph R. Beal, research director for the Radio Corporation of America, issued a statement to the press on July 21st that television will be ready for every family's use immediately after the war; that home receiving sets in any desired size with screens from 6 to 24 inches in width will be available to purchasers just as rapidly as the radio industry can re-convert to civilian production. He added that the imponderables of labor and raw materials in the post-war period precluded the possibility of naming a price range for such receivers at the present time.

On July 29th Commander McDonald raised an objection to this promise of television directly after the war by repeating what he said some four years ago: that no solution has yet been found for television's economic problem. When it is found, Commander McDonald feels that television will quickly become a great industry, but not before.

Equally if not more dubious about the near future of television is *Fortune* magazine, which carried an article titled "The Promise of Television" in its August issue. Here again the economic problem is stressed, along with the industry's disagreement over standards, the pressure of the status quo groups, the fight between television and FM for squatter's rights, and the disinclination on the part of the engineering factions to make the plunge into the cold waters of higher-frequency television channels. It's a disheartening picture for anyone with a leaning toward pessimism, but the article is worth reading in any case.

On the optimistic side of the fence we have Samuel H. Cuff, program director of DuMont's television station W2XWV. In an address before the American Television Society, Cuff said: "The advertising agencies and advertisers are the ones who will set the rules for commercial presentation of television after the war; and that now, when the television audience is necessarily limited by wartime restrictions, is the time for advertisers to test the medium, 'play around' with television and experience the growing pains of program development—by trial and error—so that when television becomes full-blown they will be ready for it."

Cuff went on to point out that television must be intimate—to be itself, so to speak. It is a close-range medium and should be used as such, and when advertisers appreciate that fact they will have found the way of exploiting the medium to its fullest extent. And this, we feel, will solve the economic problem by developing an upward spiral of return to the audience and advertiser alike.

The matter of standards and channels are something else again, but we venture the opinion that television

will be a success whether it stays put or moves into new territory. Obsolescence is a growing factor in all fields and is not peculiar to television. It is a price we pay for developing new things faster than we can put them to proper use without seriously upsetting the status quo. But in so far as the radio industry is concerned, we have already demonstrated the fact that the full impact of obsolescence can be skirted by a paralleling of services, as witnessed by the institution of frequency modulation in the midst of a well set up broadcasting structure.

## OUT OF THIS WORLD

★ There is the ever-present possibility that advertisers—and even engineers—may become completely hypnotized by the bright pictures of a new world after the war painted by copywriters who have gone to town with their imaginations, and come to believe in the super-duper. Whether or not engineers are caught up in this enthusiasm they are going to be hard put to it to satisfy the demand for dream models.

We offer both as a sobering thought and a possible release from such an obligation the following note from *Banking Magazine*: "There is nothing in the whole experience of merchandising to support the idea that people, when the war ends, will flock to buy kitchen stoves with electric eyes. . . ."

If there is any lesson in this business at all, it is that copywriters (bless 'em) should not be permitted to develop the future ahead of the engineers. It will be tough enough to develop a sufficient number of useful products to absorb production facilities without also having to introduce an electronic rocket ship for little Audrey.

## THE MEANING OF QUALITY

★ Many manufacturers of broadcast receivers found it difficult to condition themselves to Army and Navy specifications. For that matter, we have had engineers tell us that the Army and Navy specifications were outrageous, simply because they did not reduce to the physical and electrical characteristics of radio equipment produced to meet a price.

Somewhat the same attitude with regard to quality has been prevalent in the design of industrial radio-electronic equipment. Devices of this nature are of no value to an industrial plant unless they have the ability to stand up to hard usage over a long period of time without breakdown. The industrial user expects the same service from radio-electronic equipment as he does from his electric motors and other plant machinery. Until such time as manufacturers of such devices build them to last, industry will continue to question the value of radio-electronic equipment in general.





Old friends meet again...

Perhaps you fail to recognize us under this new name — Electronic Corporation of America . . . but a name really means very little. It's the knowledge and skill of an organization that count. We've been manufacturing sound systems, test equipment and numerous electronic devices, and the roots of our experience are almost as old as radio itself. The principals and most of the personnel of ECA have functioned as a unit for many years. New employees, added to our force because of the important war work we are doing, have become imbued with our cooperative spirit. Consequently, internal harmony is at its highest pitch . . . and we're able to produce just a little bit better, a little bit faster. Such a combination of experience and teamwork can't be beat. If you're in need of a dependable supplier we may, as our schedules permit, be able to help you.

*THIS WAR CAN BE SHORTENED.* Although engaged 100% in war work, we find time to seriously consider the home front. Surely the news from the battle front is good . . . but the war hasn't been won yet. In fact, we can lose it if we fail to adjust our domestic problems. Labor-management difficulties, race riots, personalities, vicious rumors . . . hurt rather than help. Let's cut them out . . . let's work together . . . let's shorten this war.

**ELECTRONIC CORP. OF AMERICA**

45 WEST 18<sup>TH</sup> STREET • NEW YORK 11, N.Y. • WATKINS 9-1870





Meat, Vegetables and Groceries

are going **UP**... but

# RCA TUBE PRICES ARE DOWN!



## NEW LOW PRICES ON THE VERY TYPES OF TUBES YOU NEED MOST

Here's one thing you can count on *for sure*—right now and in the days to come: whenever improved manufacturing efficiency makes lower tube production costs possible, RCA will pass the savings along to you in the form of lowered prices!

Take a look at these interesting examples among RCA's recently announced tube price reductions—in the face of generally rising commodity prices:

Type	DESCRIPTION	Old Price*	Present Price	Here's What You Save
803	R-f power amplifier pentode; plate dissipation, 125 watts; RCA's biggest pentode.	\$28.50	\$25.00	\$3.50
807	Beam power amplifier; full power output with very low driving power.	3.50	2.25	1.25
833-A	Amplifier and oscillator; one of RCA's most powerful glass-type triodes.	85.00	76.50	8.50
837	Heater-cathode type pentode r-f power amplifier, frequency-multiplier, oscillator; designed for exacting service.	7.50	2.80	4.70
872-A/872	Half-wave mercury-vapor rectifier; max. rating, 10,000 peak inverse volts.	11.00	7.50	3.50

\*October, 1941. Between Oct. 14, '41, and Mar. 15, '43, food prices have increased 24% (U. S. Dept. of Commerce Bulletin). RCA Transmitter Tube prices, on the other hand, have been materially reduced — an example of RCA's policy of passing the benefit of production economies on to its customers.



**For complete information write for copy of latest RCA Tube Price List.**



# RCA ELECTRON TUBES

TUBE & EQUIPMENT, DEPT. 5, RCA VICTOR DIVISION, RADIO CORPORATION OF AMERICA, CAMDEN, N. J.



from R. F. SHORT WAVE THERAPY

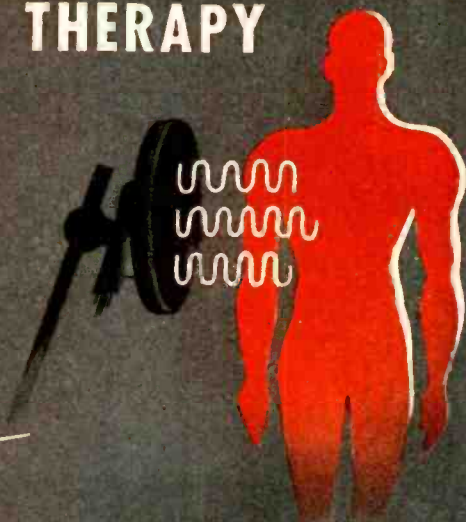
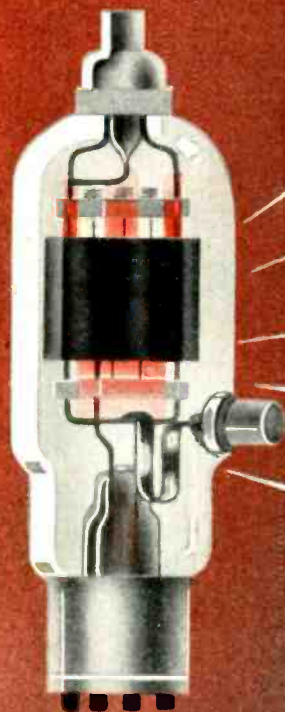

to R. F. DETONATION OF EXPLOSIVE RIVETS

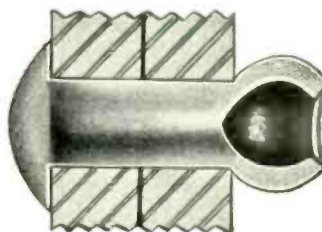

## RELAYS BY GUARDIAN



From rebuilding human bodies—to riveting aircraft structures . . . from case hardening of metals to plywood glueing . . . wherever a tube is used, there you will usually find a relay. Oscillator tubes such as are used to generate radio frequencies in diathermy machines and detonators for explosive rivets usually require a "warm up" of 20 to 30 seconds to allow the tube filaments to heat. The Guardian Time Delay Relay T-100 is frequently used in applications of this type.

The time delay is adjustable for any period between 10 and 60 seconds and is accomplished by means of a resistance wound bi-metal in series with a resistor, not shown. The contact capacity of the T-100 is 1500 watts on 110 volt, 60 cycle, non-inductive AC. The power consumption of coil and time delay during closing of thermostatic blade is approximately 10 VA; after closing, 5.5 VA. Other types of relays commonly used in conjunction with oscillator tubes are the B-100 Break-In Relay for power supply control, and the X-100 Adjustable Overload Relay for power supply and tube protection. These and other R.F. relays are described in Bulletin R-5. Send for it. No obligation.

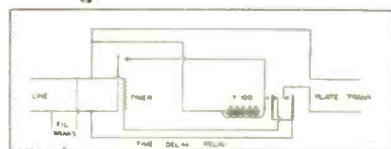
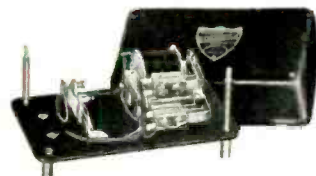

T-100 Time Delay Relay

# GUARDIAN ELECTRIC

1605-J WEST WALNUT STREET

CHICAGO, ILLINOIS

A COMPLETE LINE OF RELAYS SERVING AMERICAN WAR INDUSTRY

**RADIO**

★ AUGUST, 1943

11



## The Famous SCR-299 built by Hallicrafters



... equipped with **ANDREW Coaxial Cables**

The SCR-299 high-powered mobile transmitter, built by the Hallicrafter Co. and equipped with ANDREW coaxial cables, received high praise from Generals Montgomery and Eisenhower and their men as they drove Rommel out of North Africa. Designed to meet specific high standards of the U. S. Signal Corps, the performance of the SCR-299 has surpassed the greatest expectations of military radio men. It is highly significant that ANDREW coaxial cables were chosen as a component of this superb unit: one more proof that the name ANDREW is synonymous with quality in the field of antenna equipment.



The ANDREW Company is a pioneer in the manufacture of coaxial cables and accessories. The entire facilities of the Engineering Department are at the service of users of radio transmission equipment. Catalog of complete line free on request.

\* **COAXIAL CABLES**  
**ANTENNA EQUIPMENT**

363 EAST 75th STREET • CHICAGO 19, ILLINOIS

### RADIOTHERMICS

THE APPLICATION of radio-frequency energy to the hardening of metals is described in an article "Thin Case Hardening with Radio-Frequency Energy" by V. W. Sherman, appearing in *Electrical Communication*, Vol. 21, No. 2, 1943. This article deals with an induction heating process which establishes a thin case of hardened metal on the surface of a hardenable steel without distortion of the part, scaling of the surface, or disturbance of any prior heat-treat already established in the core. By a thin case is meant one between 0.005 and 0.030 in. This case should be controllable to within  $\pm 0.001$  in. and should be capable of reliable duplication in quantity production.

The author arrives at two rules which determine the best frequency and the power required. A high rate of energy input for a short interval is required to restrict heating to a controllable surface layer. "When the turns of the induction heating coil enclose an iron cylinder, a transformer is created whose secondary is the short-circuited surface layer of the iron cylinder. The current  $I$  which is induced into this secondary flows through a resistance  $R$  and develops heat at a rate that in watts is equal to  $I^2R$ ." In a particular induction heating coil, there is a definite number of turns and a definite maximum current, hence the ampere-turns are fixed and since the short-circuited surface secondary consists of but one turn, the theoretical maximum current which could flow is thereby determined. Due to the fact that there is less than 100% coupling, the actual induced current will be perhaps half of this maximum. "It follows that the rate of heating in the metal can only be increased by increasing the resistance of the surface layer in which the current is confined . . . the thickness of the layer in which the current is confined varies inversely as the square root of the frequency. Accordingly, if the operating frequency is increased from 1 megacycle to 4 megacycles, the thickness of the current-carrying surface layer is reduced to one half." The secondary resistance is then doubled, the heat developed is also doubled and the heat is confined to half the depth. This explains the fundamental reason for high frequency in surface hardening.

[Continued on page 19]



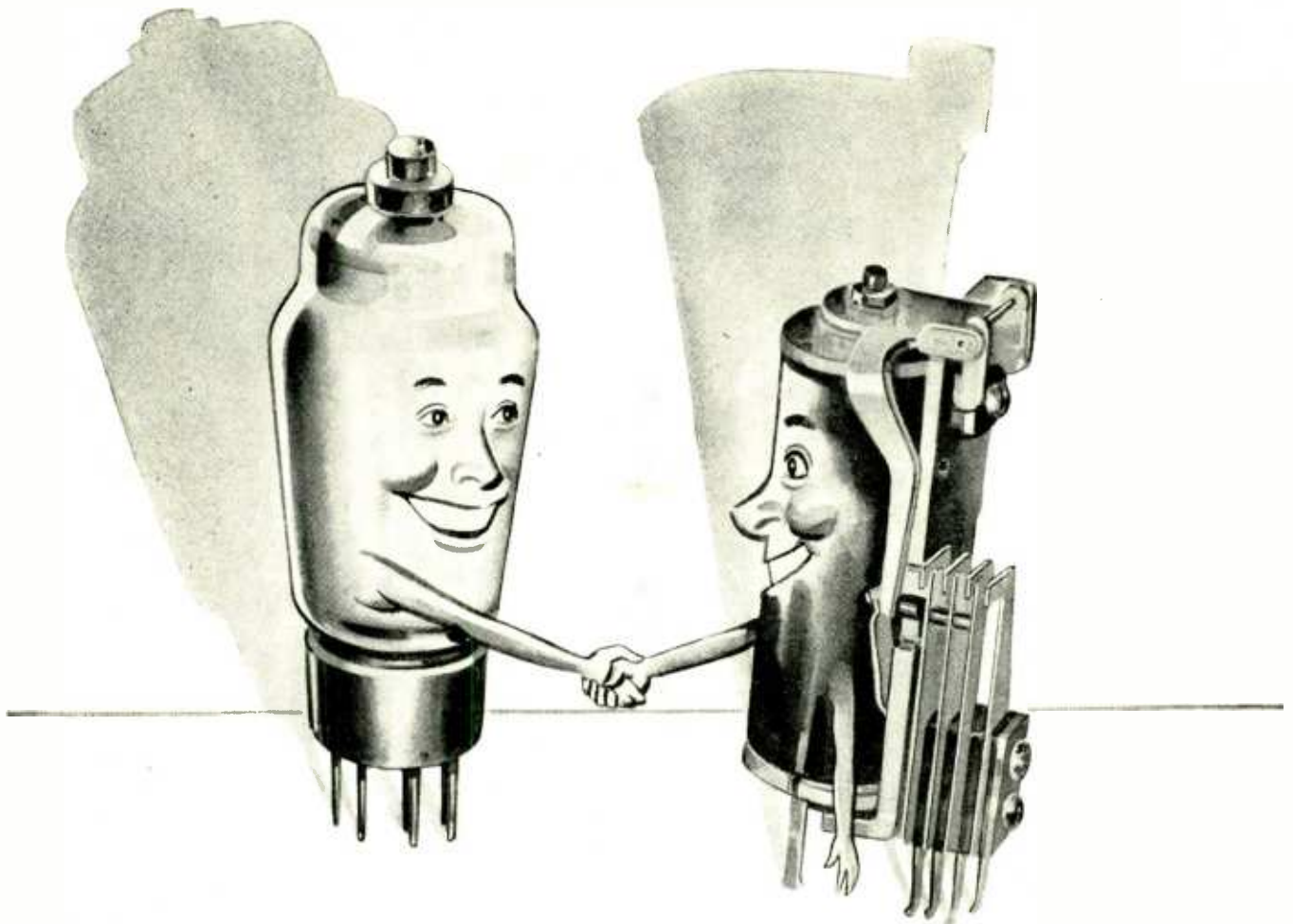

## LET'S POOL OUR KNOWLEDGE

**W**ORKING with electronic engineers in scores of industries has taught us a lot about electronic science—what it is doing to increase the effectiveness of our tools of war—how it is speeding up war production—about the miracles it promises for our postwar world.

We have learned, for example, how much this “new-old” science depends on the right electrical controls—the important part that relays, stepping switches, solenoids and other control devices play in putting electrons to work.

And that's *our* strong point. We know electrical control because that has been our sole business for over fifty years. So why not pool our resources? Let's apply *our* experience in electrical control to *your* problems in making electronic developments do a better job at lower cost.

First step in this direction is to make sure you have the Automatic Electric catalog of control apparatus.

Then, if you need help on any specific electronic problem, call in our field engineer. Behind him are Automatic Electric's fifty years of experience in control engineering. His recommendations may save you time and money.



**AUTOMATIC ELECTRIC SALES CORPORATION**  
 1033 W. VAN BUREN ST. CHICAGO  
 In Canada: Canadian Telephones & Supplies Limited, Toronto



MUSCLES FOR  THE MIRACLES OF ELECTRONICS



*Radio after the*  
**WAR**

## what price Star-Gazing?

To dream and plan realistically for the future is both good and necessary. However, to indulge in Star-Gazing through the wrong end of the telescope is an extravagance which no industry can afford. RADIO can point with pride to its achievements and its miraculous progress made under the impetus and emergency of war. But to promise that the miracles of Radar and other Electronic development will be ready for delivery on V-Day . . . is to damage an otherwise glorious record.

**THE FUTURE IS BRIGHT . . .**

**BUT LET'S KEEP OUR EYE ON THE BALL!**

Our number one job right now is the production of Radio Communications Equipment and Radar for the armed services. These are weapons which will help win the war. The application of new Electronic knowledge to peacetime radio production will, of necessity, be a gradual and evolutionary process. Your number one mass market immediately after the war will be radio and phonograph sales, and you can bet on *this*—it's going to be a "whale" of a market!



*For the development and production of Radio Communications Equipment for our armed forces, the Motorola organization was awarded the Army-Navy "E" with added Star for continued excellence of performance. Motorola is proud of the part it has been privileged to play in the speeding of Victory.*

**You May Expect Big Things from Motorola. We can't say when but we can say . . . no one will be ready sooner!**

**Motorola** **RADIO**  
**GALVIN** **FOR CAR & HOME**  
MANUFACTURING CORPORATION · CHICAGO



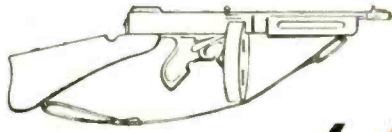

FROM THE *business* END OF THE "TOMMY" GUN...

*...comes the research engineering skill  
to speed wartime manufacture and  
solve postwar production problems*

**GENERAL**

*Electronic* 

**INDUSTRIES**

*A Division of Auto-Ordnance Corporation*

GREENWICH • STAMFORD • BRIDGEPORT • NEW YORK



Army-Navy "E" awarded to Auto-Ordnance Corporation for excellence in production of "Tommy" Guns.

● Our fighting forces needed Thompson Submachine Guns . . . thousands . . . fast! Auto-Ordnance Corporation has produced them on time!

The arsenal of freedom required tools of war production. Auto-Ordnance's Thompson Tool Division helped—is helping—to supply them!

The research engineering skill that has made good in the business of developing and producing guns, tools, vacuum tubes of both standard and special types, and other such weapons of Victory has achieved even greater, though secret, accomplishments in the fields of *Electronics, Hydraulics and Electromechanics!*

Many industrial leaders are already planning to "get the jump" on competitors after the war, with electronic devices to reduce production time, cut costs and improve precision manufacture. Perhaps we can make a notable contribution to your planning. Write to Engineering Department, General Electronic Industries, 342 West Putnam Avenue, Greenwich, Connecticut.

PRODUCTS MANUFACTURED INCLUDE ELECTRONIC CONTROLS • VACUUM TUBES  
HYDRAULIC SERVOS • ELECTROMECHANICAL DEVICES

**THE PEACETIME  
MEASURES OF RADAR'S  
REFLECTION AND  
DEFLECTION . . . .  
WILL BE READ FROM**



# **TRIPLETT**

**ELECTRICAL MEASURING INSTRUMENTS**

**WITH CONFIDENCE  
AND ECONOMY**

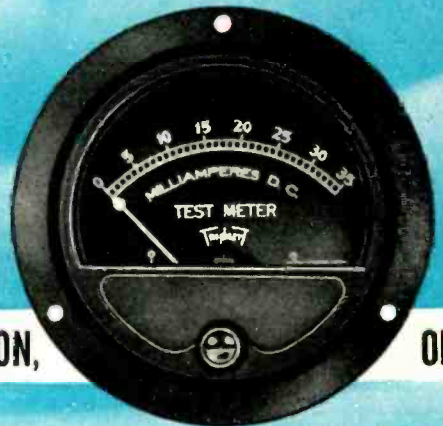

**THE TRIPLETT ELECTRICAL INSTRUMENT CO., BLUFFTON,**

**OHIO**

***BACK UP YOUR BELIEF IN AMERICA...BUY WAR BONDS***



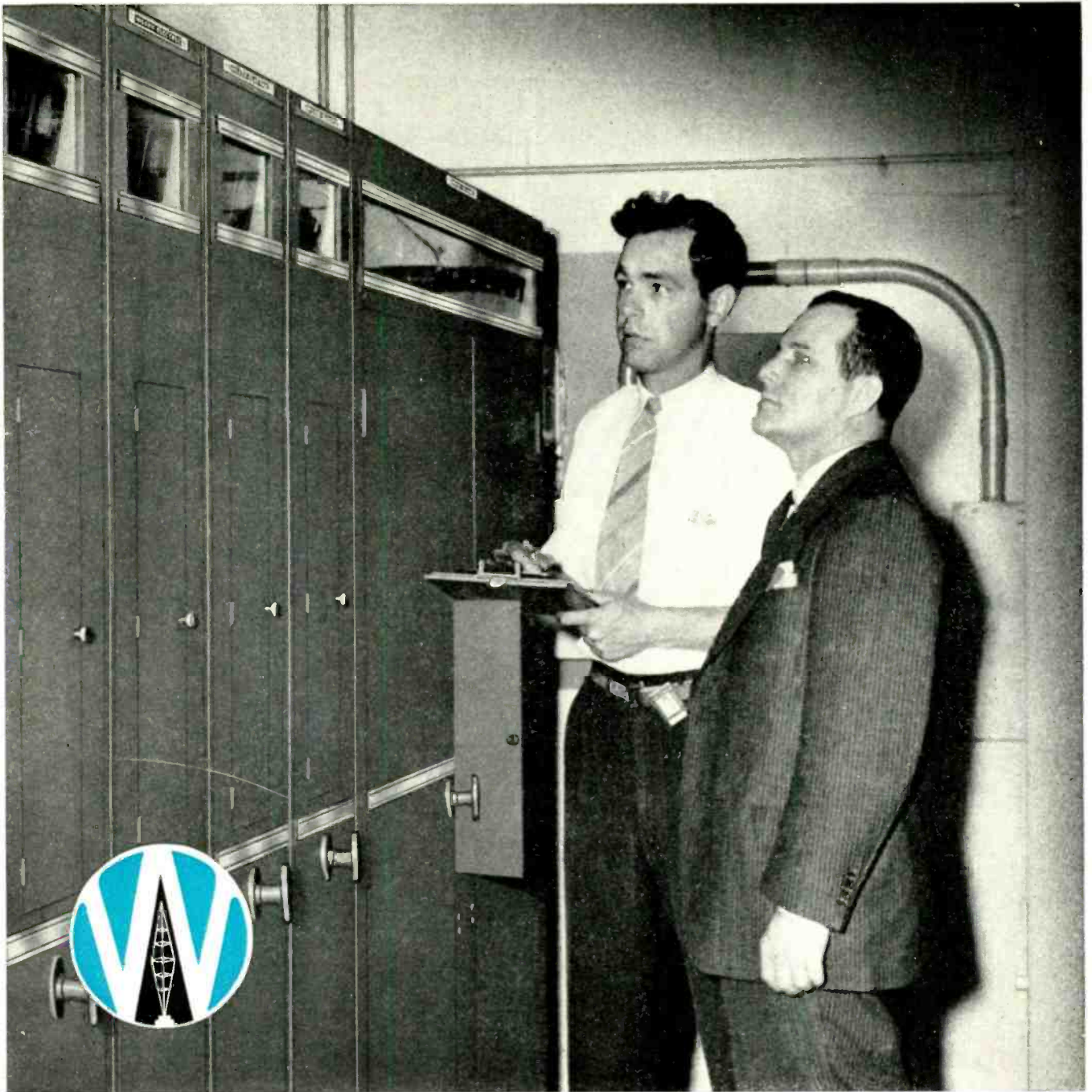

(Right) L. T. Campbell, Supt. Communications, Delta Air Lines, with J. B. Kramer, at Wilcox installation, Atlanta Station.

## SERVING THE NATION'S AIRLINES

Wilcox equipment has been used by the major airlines for many years...and while, today, Wilcox facilities are producing largely for military needs, the requirements of the essential airlines also are being handled. Look to Wilcox for leadership in dependable communications!

Communication Receivers  
Aircraft Radio  
Transmitting Equipment  
Airline Radio Equipment

### WILCOX ELECTRIC COMPANY

*Quality Manufacturing of Radio Equipment*

14TH & CHESTNUT

KANSAS CITY, MO.

RADIO

★ AUGUST, 1943

17

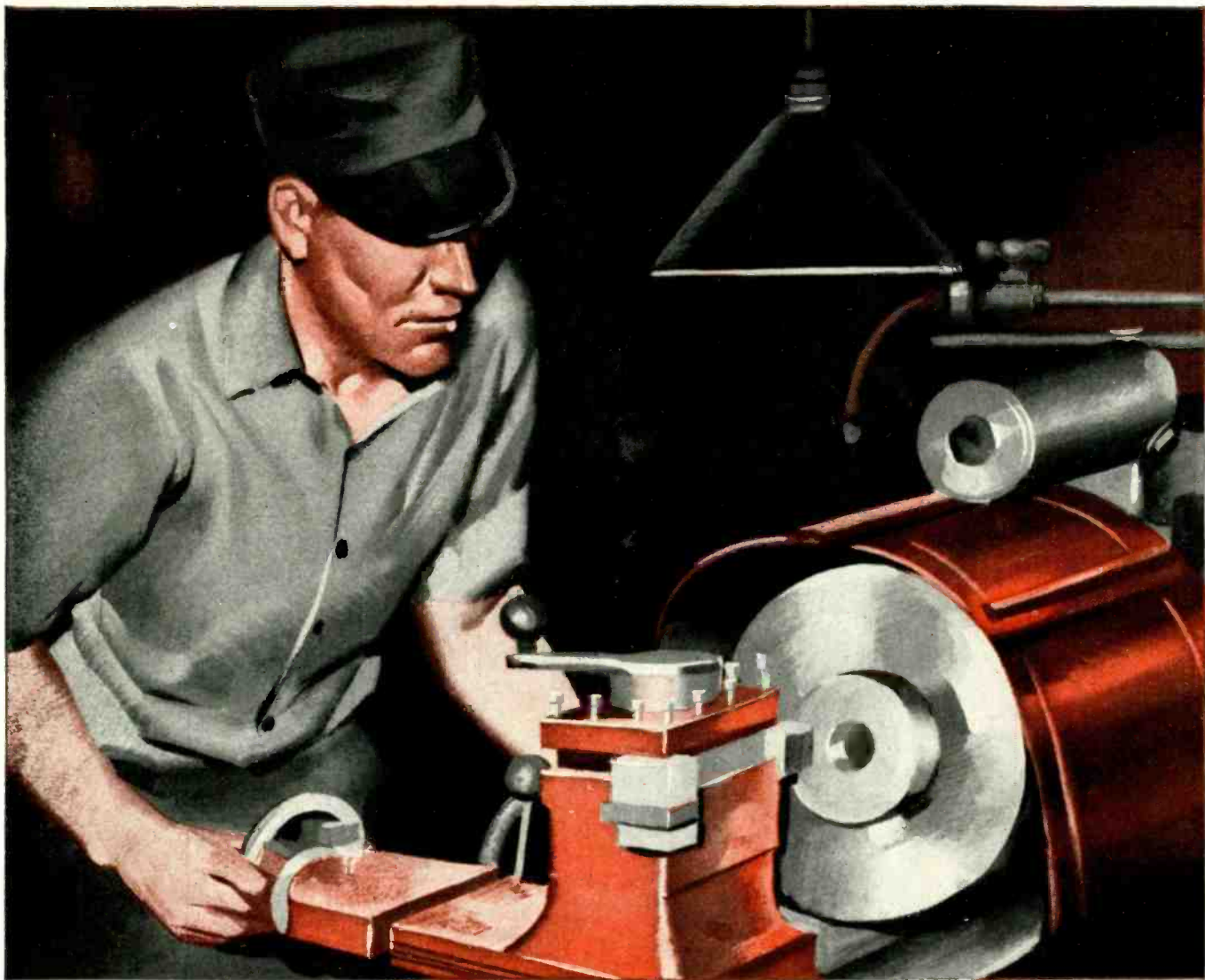

## GUNNER BY REMOTE CONTROL

**H**IS battleground is located far from the fighting fronts. His skill and long experience have been lent to the making of vital parts—parts that are vital to a boy in a bomber over Germany or his neighbor's son in a fighter in the Pacific. Their equipment is dependent on split-hair accuracy of Utah Parts—and he's giving it to them. He's a gunner by remote control.

There are hundreds like him at Utah—soldiers in coveralls. By the skill of their hands and the sweat of their brow, they're making sure that Utah Parts don't fail at the critical moment—as a switch releases a stream of machine gun bullets . . . as a headset receives a command to take a strategic height. These and many other vital electrical and electronic devices are being turned out in quantity and *on time* . . . by this precision task

force at Utah. Important to the success of this task force is the work of the Utah laboratories. Here, new solutions to electrical and electronic problems are being worked out. Here, a great store of knowledge and experience is being accumulated.

*Tomorrow* that knowledge and experience will be at the service of peacetime America. There will be better Utah products built—more convenience, enjoyment and efficiency for many Americans—because of today's great advancements, necessitated by war.

UTAH RADIO PRODUCTS COMPANY, 346 Orleans Street, Chicago, Illinois. Canadian Office: 560 King Street, West, Toronto. In Argentine: UCOA Radio Products Co., SRL, Buenos Aires. Cable Address: UTARADIO, Chicago.

**PARTS FOR RADIO, ELECTRICAL AND ELECTRONIC DEVICES, INCLUDING SPEAKERS, TRANSFORMERS, VIBRATORS, VITREOUS ENAMELED RESISTORS, WIREWOUND CONTROLS, PLUGS, JACKS, SWITCHES, ELECTRIC MOTORS**





# TECHNICANA

[Continued from page 12]

Energy is lost from a heated metal surface both by conduction to the inner layer and by radiation to the outside air. For instance, it is stated that the energy loss from 1300° F. surface of iron to an internal 75° F. layer that is located ¼ in. below the surface will be 4000 watts per sq. in.; the loss due to radiation of outside air is 75° F. is only 25 watts per sq. in.

... in surface hardening the conduction loss at the temperature in which there is interest sets a minimum heating rate requirement in kilowatts per square inch. Unless electrical energy can be supplied from the induction heating unit at a rate at least double that of the conduction loss, it is not reasonable to expect much better than non-uniform deep heating of the work which would upset any previous heat-treat of the core.

"Just how much electrical energy per square inch must be supplied beyond that dictated by the conduction loss depends upon the temperature that can be tolerated at particular depths beneath the surface. It has been found that by applying electrical energy at a high rate, a 0.007-in. layer can be hardened to 60 Rockwell C without affecting a prior heat-treat of the parent metal. To accomplish this required three times more energy per square inch of surface than the conduction loss. It also required a frequency near 5 megacycles and a time of 0.6 sec."

★

## NEGATIVE-FEEDBACK PITFALLS

THE JULY 1943 ISSUE of *Wireless World* contains an article by J. T. Terry on Negative Feedback wherein he points out that degeneration is not a cure-all for distortion and that there are cases where its application may aggravate the condition. The following extract illustrates one of these. Says Mr. Terry:

"For a start, it is necessary that the feedback should be truly negative. This does not mean pure negative feedback necessarily, but that the feedback voltage  $\beta V_o$  should contain a component 180 degrees out of phase with the applied input voltage  $V_i$ . This postulate is not quite as trivial as it may first appear, as the following example will demonstrate.

"Consider a stage of voltage amplification with transformer coupling (Fig. 1). The switch  $S$  is arranged to

[Continued on page 20]



## BD-72

● Military authorities doubt that the war will be won by any secret super weapon. They count on fighting efficiency developed out of many small things—advantages gained from foresight and painstaking attention to detail.

For example, take the BD-72 portable military switchboard developed at *Connecticut*, in cooperation with Signal Corps engineers. It has many features we can't tell you about, but we can say that the BD-72 was designed to save space, to get into operation faster, to stand a lot of rough usage under fighting conditions. Small things? Not if its small size permitted getting one more machine gun aboard the truck. Not if it helps "get the message thru" even *seconds* sooner. Small things sometimes loom large when the job is to get the jump on the enemy.

All over America, the doom of the Axis is being made more and more certain by giving the fighting men of the United Nations better fighting tools. The birth of better ways of doing things *after* the war, is an all-important by-product of this effort. *Connecticut Telephone & Electric* is an excellent source of ideas for developing your postwar product or manufacturing methods, if they involve communications, or the engineering and manufacture of precision electrical devices.

## CONNECTICUT TELEPHONE & ELECTRIC DIVISION



MERIDEN, CONNECTICUT



For the second time within a year, the honor of the Army-Navy Production Award has been conferred upon the men and women of this Division.

© 1943 Great American Industries, Inc., Meriden, Conn.

**RADIO**

★ AUGUST, 1943

19

[Continued from page 19]



## ANTS in his PLANTS!



E. M. SHIDELER W9IFI

### TINY CRYSTALS ARE HELPING DO IT

Every time a Nazi factory of war is blown sky high—every time that Hitler's tools of destruction are themselves reduced to scraps of rubble — tiny radio crystals had something to do with the job.

For communication is a vital part of warfare . . . and crystals ride with

the raiders. To fulfill their responsibility, they must be perfect. Here at Scientific Radio Products Co., we're turning out perfect crystals . . . rapidly, skillfully, steadily for Hitler's destruction.

Our facilities are such that we may be able to serve you, too, in your efforts to bring destruction to the enemy.

Write us!



LEO MEYERSON W9GFQ

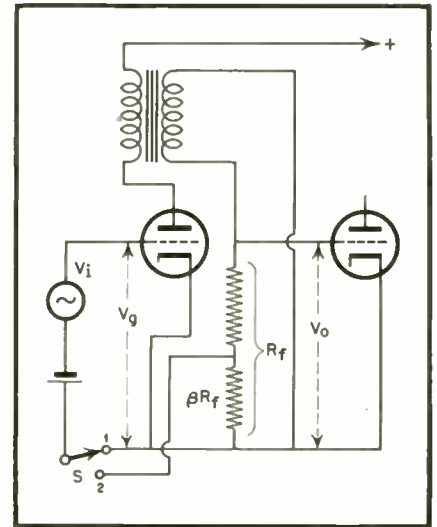

Fig. 1. Transformer-coupled stage.

apply feedback from the secondary of the transformer when in the position 2. In position 1 no feedback is applied, and providing the resistance  $R_f$  of the potential divider is adequately high, a frequency/gain characteristic as sketched in the top curve of Fig. 2 is likely to result. It reveals a poor low-frequency response below  $b$ , a resonant peak at  $d$  then a falling off rapidly towards  $e$ .

"Obviously, this characteristic is associated with serious frequency distortion and the cure would seem to lie in applying negative feedback rather than redesigning the transformer. Suppose then that the switch is thrown into position 2. Assuming that the feedback potentiometer has been suitably connected (otherwise self-oscillation is probable) the result will be disappointing as is shown in the lower curve of Fig. 2. The gain is generally lower than before, but instead of a flatter characteristic it will be adorned by an additional "hump" at  $b$ , the obnoxious one at  $d$  still being present.

[Continued on page 42]

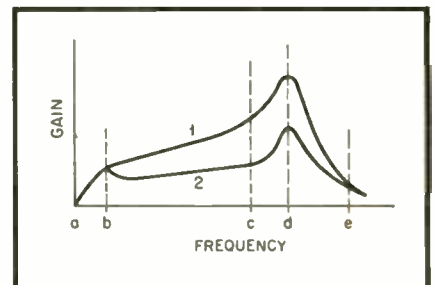

Fig. 2. Frequency/gain characteristics.

**Scientific RADIO PRODUCTS CO.**

738 W. Bdwy.

LEO MEYERSON W9GFQ  
E. M. SHIDELER W9IFI

Council Bluffs, Iowa

MANUFACTURERS OF PIEZO ELECTRIC CRYSTALS AND ASSOCIATED EQUIPMENT



# Voice communications on every front...

*Whether by radio or land wire telephone, a voice command gets the job done with clarity and speed.*

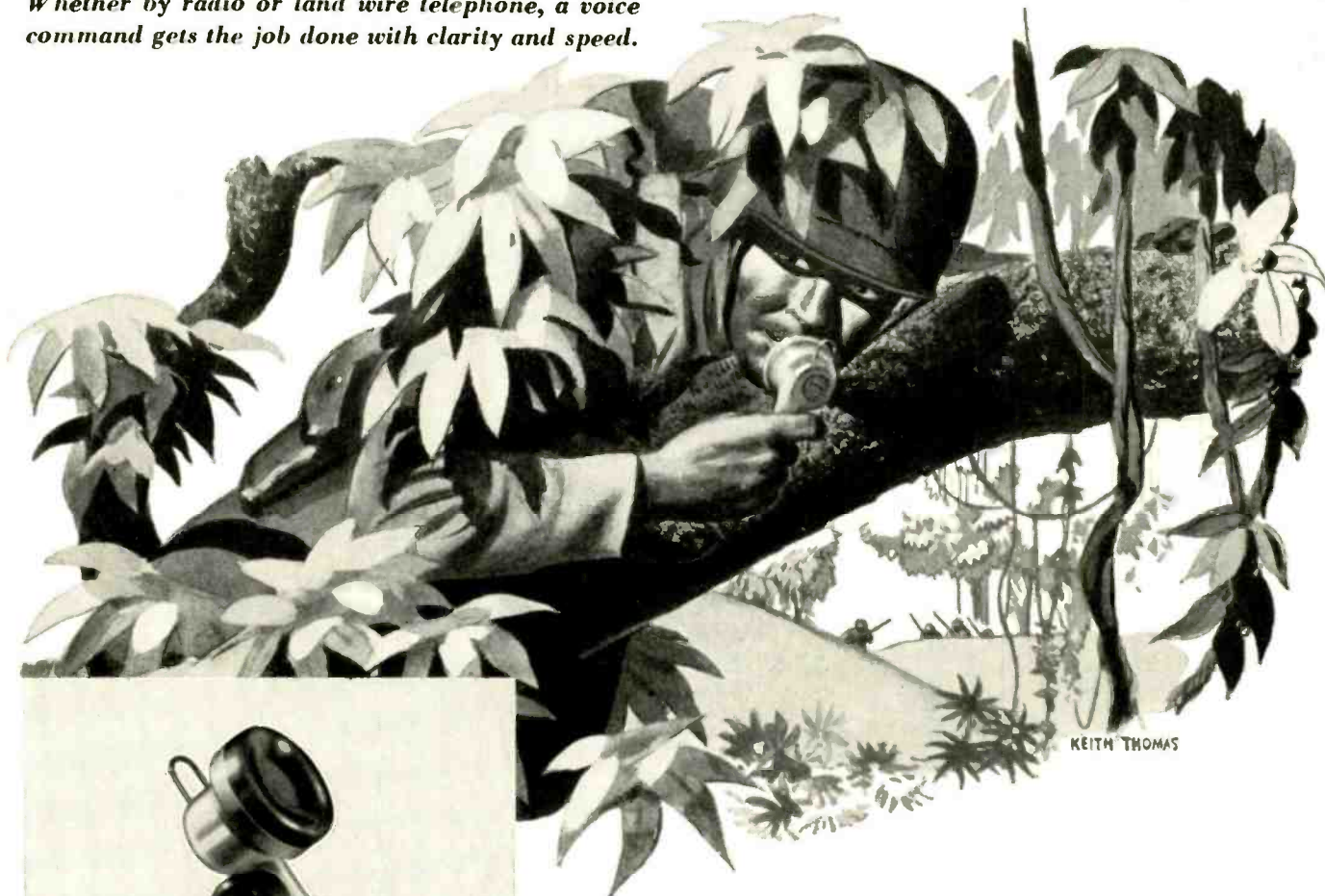

Available from stock, 1700U series microphone. Single button carbon type, push-to-talk switch, etc. For trainers, intercommunication and general transmitter service.

UNIVERSAL microphones are playing a vital part in voice communications of all the Armed Forces . . . being the first instrument through which a command is given. Care must be taken that the electronic patterns of the voice are held true for the many electrical circuits through which they must later pass. UNIVERSAL microphones with their precise workmanship are carrying the message through in all forms of voice communication whether from a tank, ship or aeroplane. UNIVERSAL products meet all U. S. Army Signal Corps Laboratory tests. Standardization of parts, inspection, and workmanship of high order combined with the best of material, make UNIVERSAL'S microphones and accessories outstanding in every application.

*U. S. Army Signal Corps and U. S. Navy plugs and jacks are offered as voice communication components to manufacturers of transmitters and sound equipment for the Armed Forces. Catalog No. 830 contains complete details.*



**UNIVERSAL MICROPHONE CO. LTD.**  
INGLEWOOD, CALIFORNIA

FOREIGN DIVISION, 301 CLAY ST., SAN FRANCISCO 11, CALIF. • CANADIAN DIVISION, 560 KING ST. W., TORONTO 2, ONTARIO

RADIO

★ AUGUST, 1943

21



*In War...*

*In Peace...*

**OUR BUSINESS IS  
MAKING LOUD SPEAKERS**

*Now being used for military communication, detection and similar war time uses...  
built to those high standards of precision,  
durability and performance born of habitual  
peace time practice.*

**Jensen**

**RADIO**

**MANUFACTURING COMPANY**

6601 SOUTH LARAMIE AVENUE, CHICAGO



# POYNTING'S VECTOR IN WAVE GUIDE AND RADIATION PHENOMENA

V. J. YOUNG

Sperry Gyroscope Company, Inc.

★ The most commonplace picture of the mechanism for the transfer of electrical energy is based alone on the concept of charge and voltage. It demands that there must always be a closed electrical path. There must exist one side of the circuit to carry charge from the generator to the load and another by which the charge is returned. Each charge is then considered as a conveyor of energy (*Fig. 1*). We define voltage as energy per coulomb and hence the voltage across the load represents the energy carried to the load by each coulomb. The energy received by the load depends upon the amount of charge multiplied by the voltage; that is, it depends upon the energy carried by each charge times the number of charges. The power at the load is the time rate at which energy is received, or the current times the voltage.

## Kirchhoff's Laws

When the headlights of an automobile are turned on, energy must be supplied to the filaments of the lamps. Charge is carried to them by a wire from the storage battery. As it leaves the battery each charge has six joules of energy. It loses practically none of this on the way up to the headlight because of the low resistance of the wire. In the relatively high resistance of the headlight, however, it gives up most of its energy (i. e., a voltage drop occurs) retaining only enough to allow for the return trip to the battery either on a second wire or through the metal framework of the car. This fact is expressed by the second law of Kirchhoff which sums up the argument very elegantly by saying, "The sum total of the voltages around any closed electrical path when taken with due regard for polarity must be zero." This in connection with the first law of Kirchhoff, which effectively specifies that charge cannot be made or destroyed,

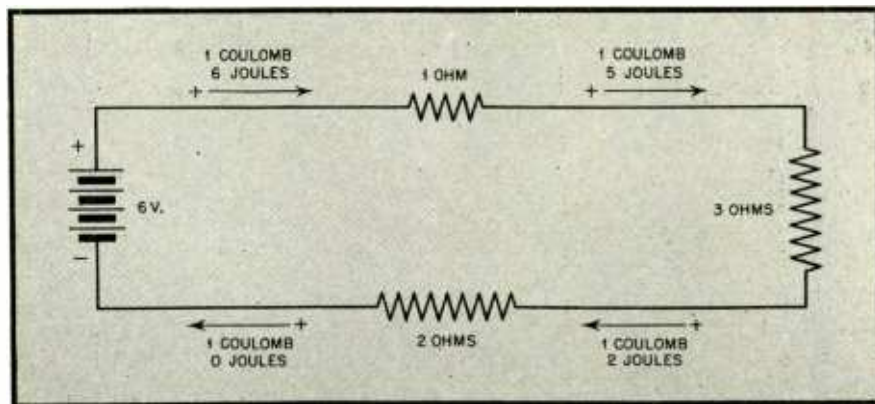

Fig. 1. As a positive charge of one coulomb travels around the circuit, it carries energy to the various loads in accordance with Kirchhoff's second law.

turns out to be all that is needed to solve any circuit problem.

With alternating currents of even moderately low frequency the picture becomes a little more difficult. We are then forced to think of the wires as continuously swapping their functions of supplying charge to the load and returning it to the source. When capacitors are part of the circuit, we have to allow for the fact that no charge can actually pass through the dielectric. We say that this is all right because all charge is exactly alike and we know from Faraday's famous ice-pail experiment that every time a charge comes onto one plate of a condenser another just like it is forced off the other plate. In effect we still can say that the charge flows in closed paths. Kirchhoff's laws are still valid and except for the mathematical difficulty of handling the equations they still allow a solution to be obtained for any circuit.

In fact all that has been said is still true even when we go to extremely high frequencies and electrically long lines. In this case a given charge simply does not have time, even though it is traveling with a velocity nearly equal to that of light, to make the com-

plete trip before a reversal of direction occurs. Even then, fruitful results may often be obtained in terms of voltage and current.<sup>1</sup> Effectively we again say that all charge is alike and that although currents may be flowing in both directions at various points along a conductor, still, on the average, equal amounts of charge leave the generator and return at the other pole and Kirchhoff's laws still hold.

## E and H Quantities

In other cases, however, such as with the transmission of radio waves through space or with the transmission of microwaves through a hollow pipe or wave guide, the closed path travel of charge, although it still exists, is very difficult to trace. It is difficult because voltages may now instantaneously appear across small lengths of good conductors due to the time necessary for the motion of charge and because a conductor may at different points be simultaneously carrying current in more than one direction. When this is true it is well to consider some

<sup>1</sup> "Mismatching in Coaxial Lines," *Radio*, May 1943, and "Dissipative Losses in Coaxial Lines," *Radio*, June 1943.

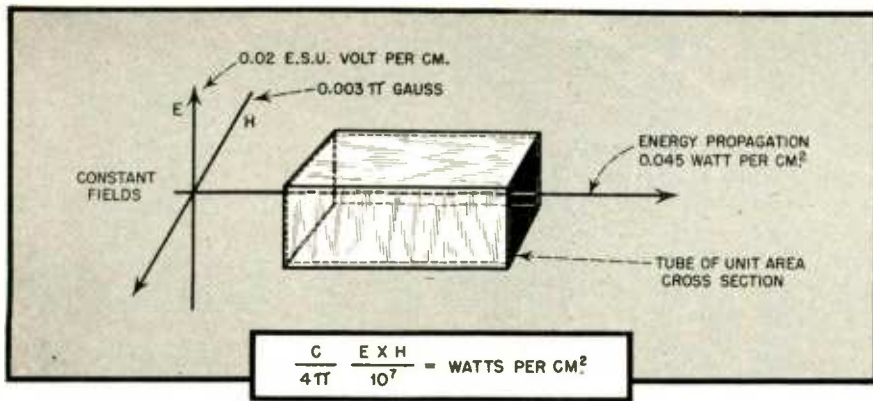

**Fig. 2.** The presence of  $E$  and  $H$  vectors at right angles to each other indicates an energy flow which is at right angles to both of them. Their product measures the energy flow per square cm. which in a constant field is the power through the imaginary unit area tube shown.

between the plates we would find it to have a value of  $0.008\pi$  gauss. A measurement on the electric field,  $E$ , would yield a value of 0.01 electrostatic volts per centimeter. Here, since  $E$  and  $H$  are at right angles to each other, an ordinary product of these quantities multiplied by a constant,  $3 \cdot 10^{10}/4\pi$ , which is necessary to keep the dimensions straight, gives the energy flow per square centimeter.

This quantity is called Poynting's vector.

$$P = \frac{3 \cdot 10^{10}}{4\pi} \cdot E \times H = \frac{3 \cdot 10^{10}}{4\pi} \cdot 0.01 \cdot 0.008\pi = 6 \cdot 10^8 \text{ ergs per square cm. per sec.}$$

other method of formulating the problem; some other quantities besides voltage and current which will supply us with information about the flow of electrical energy. We find two such quantities in the electric field which is denoted by  $E$ , and the magnetic field which is denoted by  $H$  (Fig. 2). There is essentially no more difficulty in visualizing these quantities and the way they transfer energy from the source to the load than there is with charge and voltage. Usually it is only a lack of familiarity that makes  $E$  and  $H$  seem more difficult. As for the mathematical details for obtaining a quantitative solution, either system of analysis may in certain cases be the best one.

At least two advantages are incurred by thinking of energy propagation in terms of electric and magnetic fields. One is that no concept of a return path is needed. It is only necessary to trace the electric and magnetic field from the load to the source. The second is that unlike currents, field quantities can travel through a vacuum or dielectric. The solution of any given problem is thus always one of satisfying boundary conditions. If we can know the values of the fields in enough places; that is, if we can satisfy the boundary conditions, we can give their values elsewhere and hence the energy flow to the point in question.

In general at low frequencies where a two-wire system can be easily traced and all mutual inductances and coupling coefficients be specified, it is better to design electrical transmission systems in terms of voltage and current. At very high frequencies where the round trip path of all currents is difficult or impossible to follow, it may be better to work with the electric and magnetic field. In principle at least, either will always work. Thus, to see how a problem may be solved in terms of  $E$  and  $H$  as well as  $V$  and  $i$ , let us

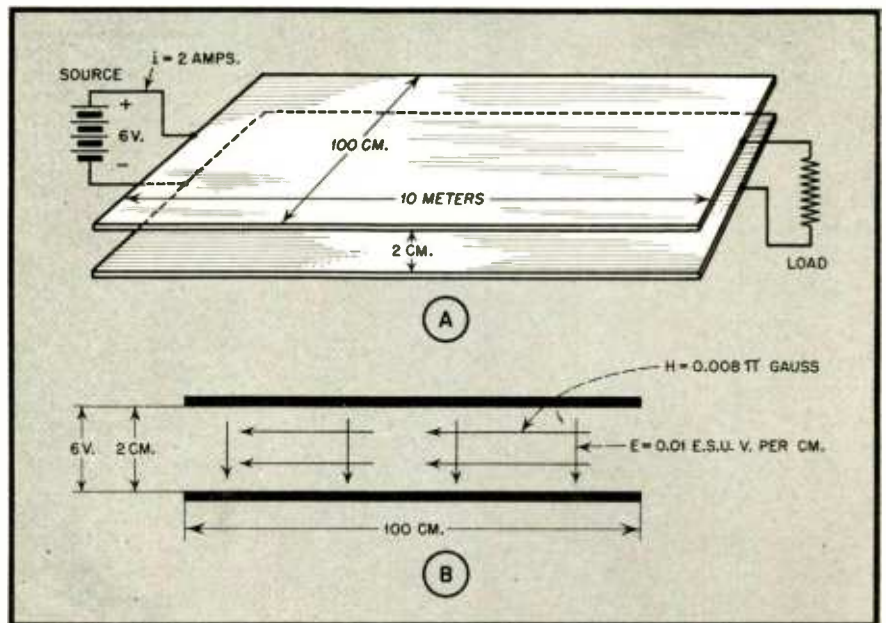

**Fig. 3.** In this circuit the energy flow may be easily calculated in terms of  $E$  and  $H$ . Fig. 3-B is intended to be an end view of the plates as seen from the source end.

first consider a simple direct-current electrical source connected to a load through peculiar conductors so shaped as to make the solution of the problem feasible by either method of attack.

### Working Example

In Fig. 3-A is shown two strips of metal each one meter wide and 10 meters long. One of these strips is laid flat on a table and the other is suspended 2 cm. above it with air or vacuum in between. A 6-volt storage battery is connected between the strips at one end and a load resistor is placed at the other end. The resistor has such a size that two amperes of current flow.

To find the power by ordinary methods we would measure the voltage with a voltmeter and the current with an ammeter and upon multiplying the two together obtain an answer of 12 watts. Similarly, neglecting edge effects, if we were to measure the magnetic field,  $H$ ,

We here visualize the energy as traveling in the space between plates. This viewpoint may seem less natural than one in which the energy is more closely associated with the charge, but it represents an equally valid way and is more helpful in explaining radiation. Poynting's vector represents the energy flow through each square cm. of the space. Changing the units to watts per square cm. instead of ergs per square cm. per second, we may give the value of Poynting's vector as

$P = 0.06$  watts per square cm.  
The cross-sectional area is 200 square cm., so multiplying we find the total power to be 12 watts as before.

In Fig. 3-B all of this is perhaps shown more clearly. Here we have an end view of the plates shown in 3-A. The electric field which always points toward negative charge is represented by the vertical vectors. For the vacuum or air case the dimensions of  $E$  (volts



per cm.) are nearly as good as a definition.  $E$  is a vector quantity. This means that it may be represented by an arrow whose head points to negative charge and whose length tells us how rapidly voltage changes through space. With infinite parallel plates such as we have here (neglecting anything irregular at the edges), we find the magnitude of the vector simply by taking the total voltage (6 volts) across the space (2 cm). and dividing by the space. This gives 3 volts per cm. Changing to electrostatic units, we obtain the value mentioned above.

### E as Force

We may also define  $E$  in terms of a force. The point is that  $E$  is a property of space due to currents or charge on nearby conductors. In Fig. 3-B we have drawn the  $E$  vectors in the space between the plates. A nice way to define  $E$  in such a case is to say that it is the force on a unit positive charge. Thus, imaginatively, if one takes a positive charge in his fingers and holds it between the plates, he finds it is attracted to the negative plate. This force of attraction indicates the strength of the electric field at the point where one holds the charge.

Also in Fig. 3-B we have drawn vectors representing the magnetic field. These arrows drawn parallel to the plates and perpendicular to the currents are also to be thought of as indicating a property of a point in space. This time it is a property which depends on whatever currents are flowing in the neighborhood. The direction in which the  $H$  vectors are to be drawn can be determined by putting a small magnet at the point in question. It will turn like a compass and indicate the direction of  $H$  with its north pole. If this same magnet is then twisted through an angle of 90 degrees, the torque

necessary to hold it there can tell us the magnitude of the  $H$  vector. It is also possible to calculate  $H$  from the known currents just as we can find  $E$  from known voltages. To do so we must make use of Ampere's law. A calculation with it confirms the value of  $H$  we have given.

With the storage battery and the two strips of metal, the calculation of  $E$ ,  $H$ , and Poynting's vector has been rather the long way around to finding a simple answer of 12 watts. It would have been even worse if we had dealt with an ordinary pair of wires. Now we must justify our trouble to understand the method by looking at something solvable in terms of  $E$  and  $H$  but not in terms of  $V$  and  $i$ .

### Antenna Radiation

The radiation from a transmitting antenna is in a sense just the opposite to the way a piece of resistance wire absorbs energy. This is illustrated in Fig. 4. Fig. 4-A represents a short length of resistance wire through which a positive current is flowing from left to right. Since we have said that an electric field can be measured by the force on a positive charge, the electric field must also be from left to right. By the right hand rule, the magnetic field must be as shown. Now with crossed  $E$  and  $H$  vectors, if we pretend to rotate  $E$  into  $H$  like a right hand screw, the motion of the screw shows the direction of the energy propagation. Thus with resistance wire the energy apparently flows into the wire. Detailed calculations will show that with the  $E$  and  $H$  picture this flow will be just enough to account for the heating of the wire as is usually given by the  $i^2r$  loss.

With radio frequencies and low-resistance wire such as would be used in an antenna, the opposite is true on

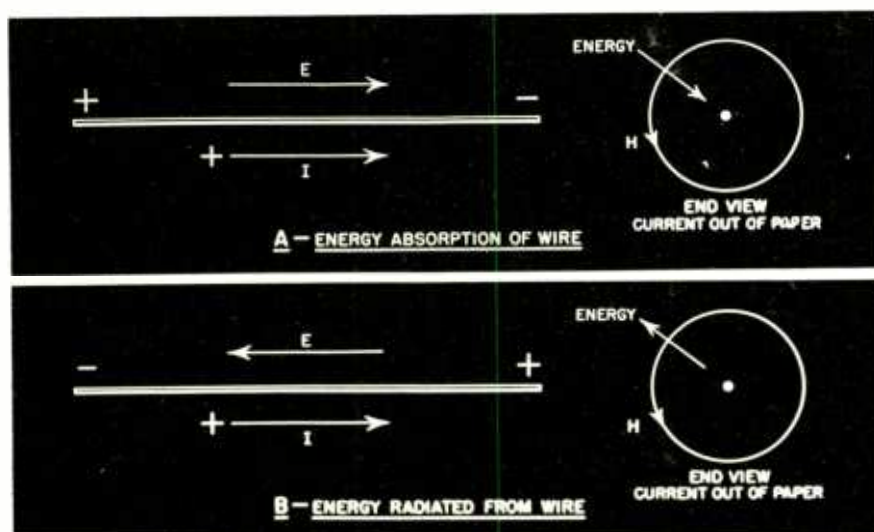

Fig. 4. In A it is shown that energy being guided along a resistance wire will flow into the wire. B shows how energy guided by an antenna may move out into space.

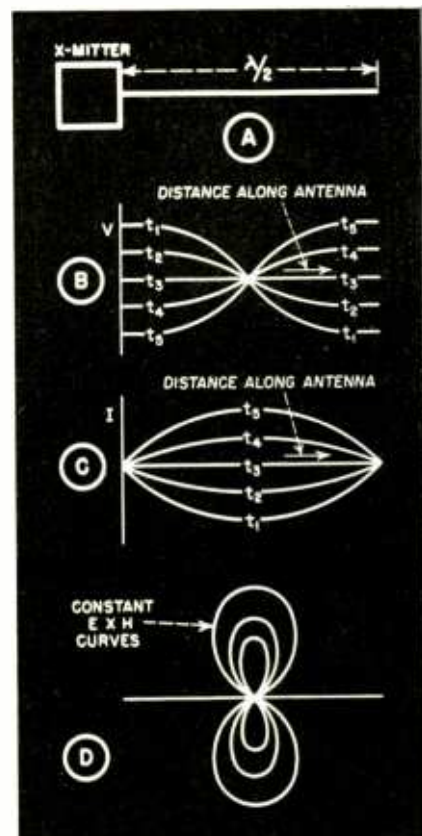

Fig. 5. A half-wave antenna is indicated in A. The potential of this antenna is shown for five values of time in B. C shows the same data for the current. The curves of D (which are really surfaces of revolution obtained by revolving the curves about the antenna as an axis) show the radiation pattern of the antenna. Each curve represents a locus of equal values of Poynting's vector calculated from the voltage and current distribution.

the average. At some time a current starts to flow but before the charge has gone far ( $\frac{1}{2}$  wavelength) the voltage reverses. Especially if the antenna is properly tuned  $E$  can be made to point in the direction shown in 4-B. If we then apply the rule of the right hand screw, we find that energy will flow out away from the wire. One-half cycle later both  $E$  and  $H$  (also  $V$  and  $i$ ) will be reversed, but that too will give the energy flow as outward.

Fortunately it is quite easy with an antenna to calculate both  $E$  and  $H$  if the current is known. A rather simple expression for the radiation from a short length of wire may be formulated in terms of the current, frequency, distance, and angle from the radiating section.<sup>2</sup>

<sup>2</sup> Terman, "Radio Engineering." McGraw Hill, 1937, page 648; R. R. Ramsey and Robert Dreisback. "Radiation and Induction," *Proc. I.R.E.*, Vol. 16, p. 1118, August 1928.

In Fig. 5, the case of a straight wire, half-wave antenna well separated from the ground is shown. The curves of voltage indicate that a maximum voltage appears across the ends. That is, at time  $t_1$ , the transmitter end is positive and the far end negative. This

the neighborhood, then, likewise, only at that point must be finite values of  $E$  and  $H$ . At a moment later the energy pulse has moved and is still traveling eastward. Hence  $E$  and  $H$  may be thought of as also moving through space. In fact it may be shown that we

of Fig. 6-A. We know in accordance with Maxwell's equations that as these lines change, as they surely will, since we are dealing with high-frequency alternating current, contour lines of  $H$  will also appear. These are shown at the extreme left end of Fig. 6-B. A simultaneous examination of both parts of Fig. 6 shows that we thus have crossed  $E$  and  $H$  vectors and hence a propagation of this pattern along the wave guide.

If the load end of the wave guide is perfectly matched, it is quite easy to visualize the motion of the  $E$  and  $H$  contours (lines of force).  $H$  moves down the pipe of Fig. 6 like a series of smoke rings while the electric lines radiate out from the center of the pipe being distributed in time (and hence in distance along the pipe) in accordance with the sine wave form of the input voltage.

### General Design

It should be remembered that this is only a single example of wave-guide propagation. It is not necessary that the pipe be cylindrical, and even if it is, the waves may travel in some different manner. These various types of transmission are called modes of propagation. The particular mode in which a wave will travel along a pipe depends upon the method of excitation and the shape and dimensions of the guide.

We can say in general, however, that in any wave guide problem we must first in some way introduce a crossed electric and magnetic field into the source end. This will then automatically attempt to transfer energy into the guide. Whether or not transmission will occur along the guide and in what mode will depend on boundary conditions. Mathematically we can write down a differential equation that contains the solutions of any wave problem. That equation is known as Poisson's equation. To design a wave guide to do a particular job the problem is to choose such a shape and dimension as to allow a solution of the wave equation to be obtained which will have proper boundary values at the metallic surfaces.

Fortunately, for making measurements on actual wave-guide installations, the ratio of  $E$  and  $H$  is usually a constant. In free space it is 300 to one. In a specific type of guide it may well have a different value but still a constant one depending on the inductance and capacitance and hence the geometry of the wave guide. This ratio may usually be calculated so it is only necessary to measure  $E$  in order to compute Poynting's vector. Even if the  $E$  to  $H$  ratio is not found, measurements on  $E$  alone are sufficient for relative calculations of power flow.

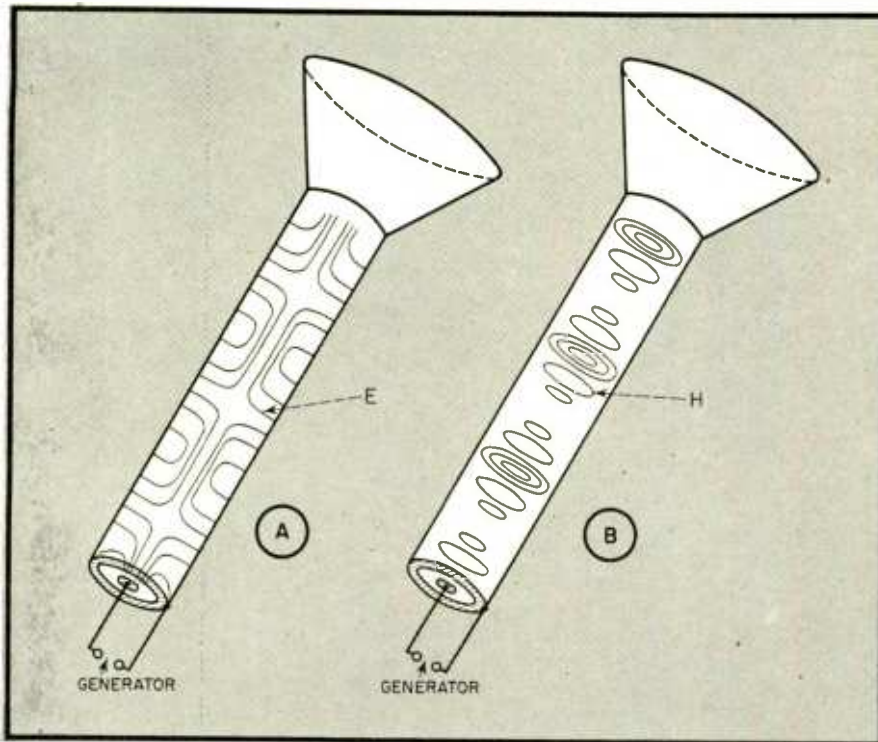

Fig. 6. Here a simple mode of energy transfer in a cylindrical wave guide is illustrated. The  $E$  and  $H$  lines are shown in separate drawings for clearness. The two taken together show that with a proper wave length it is possible to apply a source voltage so as to get crossed  $E$  and  $H$  vectors.

means that at that time, an electric field points outward along the antenna. Since a current is then flowing inward toward the transmitter, energy is radiated as was illustrated in Fig. 4. At a time  $t_2$  the voltage and current are less; at  $t_3$  they are zero and at  $t_4$  and  $t_5$  they are increasing again but with  $E$  and  $H$  directed in the opposite sense.

In Fig. 5-D a radiation pattern is shown. Its form can be calculated by finding values of  $E$  and  $H$  in the neighborhood of the antenna. What has been drawn is really a contour map of  $E$  and  $H$ . Every point on each curve has the same value of  $E$  and  $H$ . Evidently if such an antenna is erected vertically, very little energy is sent upward or downward and a non-directional sideways coverage is obtained.

We have specifically said that the product of  $E$  and  $H$  gives information about energy flow. What is implied, moreover, is that a given value of  $E$  and  $H$  travels along with the energy. If at some place in space we have a pulse of electromagnetic energy traveling eastward and no other energy in

can give an expression for the energy per unit volume in space. It is:

$$\text{Energy per unit volume} = \frac{\epsilon E^2 + \mu H^2}{8\pi} \text{ ergs per cm.}^3$$

### Wave-Guide Picture

This idea of closely identifying the flow of electromagnetic energy with the motion of a wave of  $E$  and  $H$  is very valuable in understanding wave-guide phenomenon. From this viewpoint it is only necessary to see that certain values of  $E$  and  $H$  occur at certain times at the source end and then to follow these values as they move along the pipe.

In Fig. 6 the  $E$  and  $H$  waves are illustrated for the simple case of a cylindrical pipe fed with an appropriate frequency. A possible way of introducing the energy into the pipe is indicated by the annular insulation placed in the otherwise closed source end. If at some instant a voltage appears across the generator, then at that time contour lines of constant  $E$  may be drawn between the input electrodes as are shown at the extreme left end



# SOME SUGGESTIONS FOR

# STANDARDS OF GOOD OPERATING PRACTICE

# IN BROADCASTING

HAROLD E. ENNIS

Technician, Station WIRE

## PART I

★ There is probably no greater gap in all literary history than that existing between the field of radio engineering and design, and the practical operation of the final product under actual use. This is especially true in the field of broadcasting. Very likely this is due to the somewhat limited circle of engineers concerned with broadcast operations, yet there is no subject of interest more expansible or inexhaustible.

This article is thus intended pri-

marily to be a brief treatise of control room and transmitter operation for broadcast technicians; endeavoring to collect enough co-ordinated facts that could result in a general set of rules to serve as standards of good operating practice. An attempt is made to bring forth a new approach to modern operating technique, and to discuss and clarify existing facts that should lead to a better understanding between studio and transmitter personnel.

The discussion necessarily includes

an analysis of different types of indicating meters used in practice, in order that their functions may be better interpreted and understood in relation to the work which they are intended to perform. Related subjects, such as loudness sensation for a given meter reading, waveform, phase shift in studios, etc., are analyzed.

The subject and content of this paper is intended not only for the many newcomers to control rooms and transmitters, but also for the "old timers" fa-

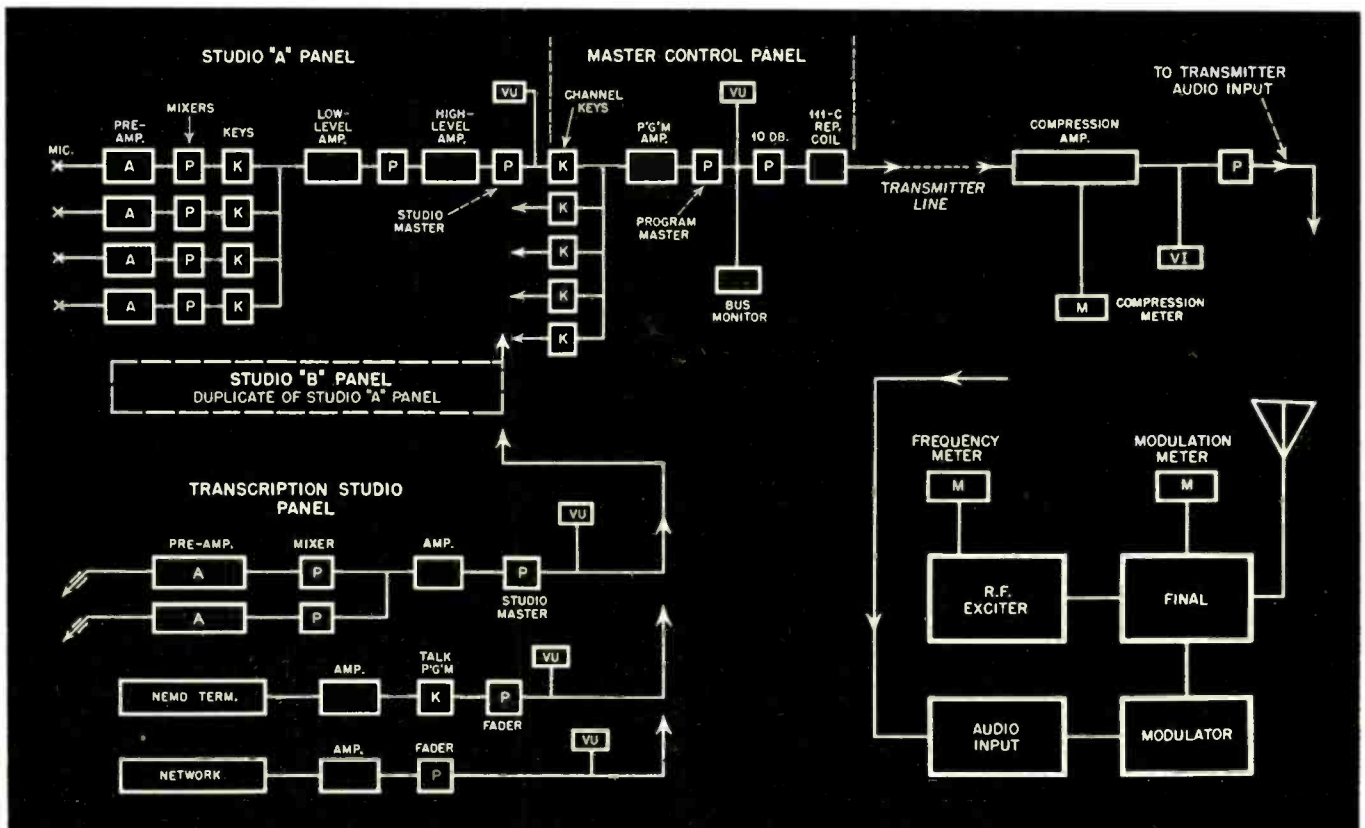

Fig. 1. Simplified block diagram of studio and transmitter set-up.

miliar with all the problems peculiar to their work.

### Typical Set-Up

In order to better visualize some of the discussion to follow, it may be well to refer to the block diagram of a typical broadcast installation, as shown by Fig. 1. Most of the sketch is self-explanatory, showing in simplified form the set-up necessary for mixing and blending of voice and music from a specified studio, switching of studios, remote and network lines, visual and aural monitoring facilities, wire transmission to the transmitter and associated equipment.

The pad preceding the 111-C repeater coil in the Master Control circuit is used to provide a constant load at all times for the channel amplifier, and is necessary since the equipment operates

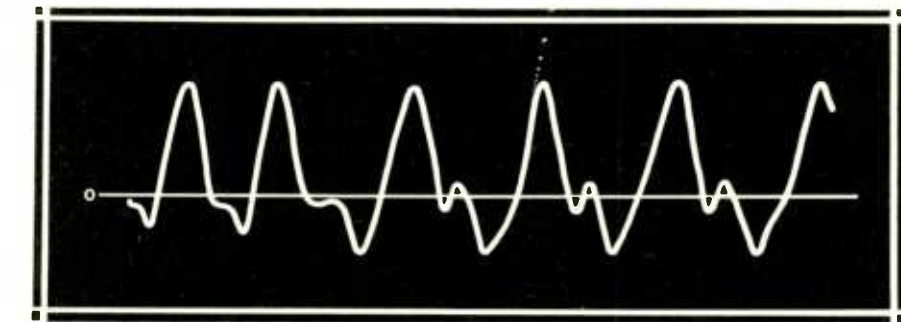

Fig. 3. Graphical integration of typical speech wave showing lack of symmetry.

energy sufficient for 0 vu deflection, instantaneous peaks will exist of several times 1 milliwatt energy, and average power will be a fraction of 1 milliwatt.

As may be seen from the block diagram, visual indication of the program in progress is provided on the Studio

necessary that it be understood only in relation to the electrical and dynamic characteristics of the meter used, and the technique of reading its response.

### Volume Indicators

Perhaps this will be clarified by Fig. 2, showing the response of two typical volume indicators on a suddenly applied signal. This difference in dynamic characteristics of the new and old type volume indicators, both illustrated, shows the need for a difference of technique in using the interpretation of the meters. The operator experienced on the old type of VI became accustomed to permitting the sudden overswings on certain types of programs to maintain effective values of level. The standardization of the new type indicator is a great step forward in broadcasting and most stations are equipped with these meters today.

It must be remembered, however, that modulation monitors at the transmitter must necessarily be of the peak-reading type, since this is specified by the FCC; whereas the vu meter used at the studio is meant to integrate whole syllables or words. A typical modulation meter reaches 100 on the scale in approximately .09 second when a 1000-cycle voltage of the required amplitude is applied to the equipment, whereas the vu indicator reaches 99 in 0.3 second under similar conditions.

Coupled with this difference of dynamic characteristics of the two meters, is the conventional habit of monitoring at the transmitter on a single pole of the modulated envelope, either positive or negative peaks. By studying Fig. 3, which is a graph drawn from a typical oscillograph of speech wave, it can be noted that the energy in positive and negative peaks is far from equal. This is typical of speech waves at the output of a microphone, regardless of the type or make of microphone used. Since the vu meter works from a balanced full-wave rectifier, its reading is not dependent on the pole of operation, and thus the comparison of the indication at the transmitter modulation meter position with that at the studio

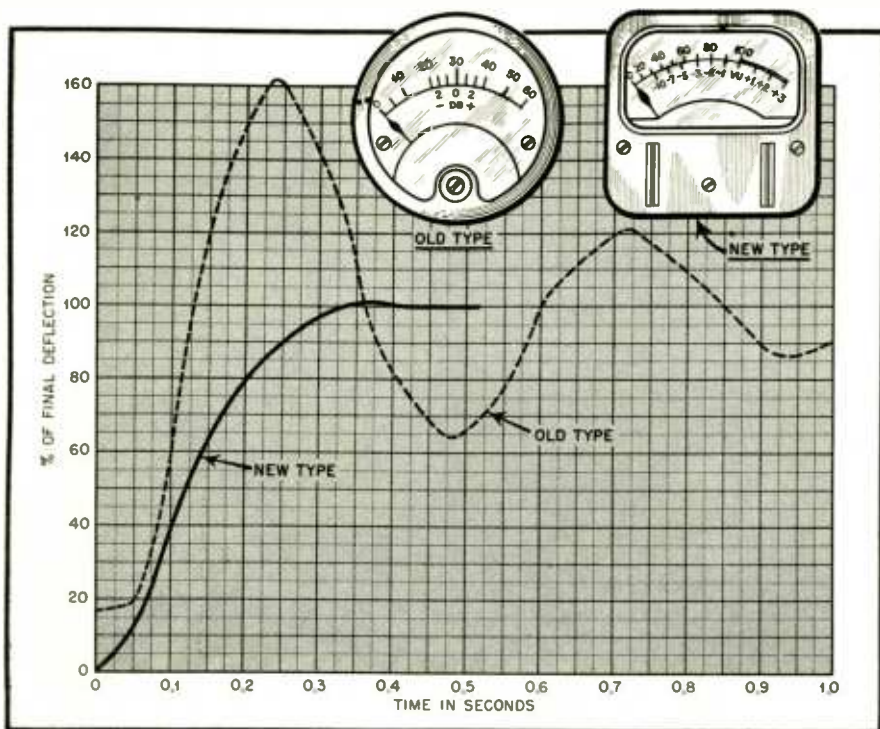
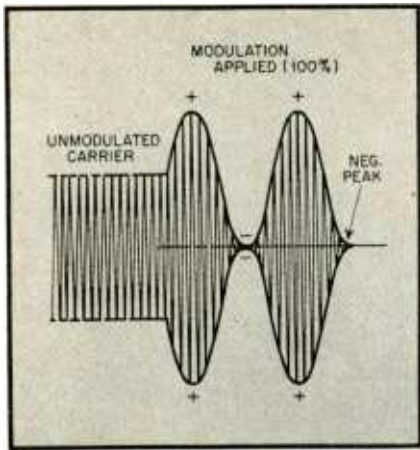

Fig. 2. Response of two typical volume indicators on a suddenly applied signal.

at a higher level than is deemed advisable to feed into program lines of the telephone company. The new standard VU meter bridged across the monitoring points are supposedly indicators of 1 milliwatt of power (sine-wave) in 600 ohms. Actually they indicate 0 vu with a sine-wave power at 1000 cycles of between +4 vu and +26 vu, depending on the external resistance used in series with the meter to allow greater bridging characteristics. RMS meters of greater sensitivity have not proved practical to date. It must be kept in mind, however, that this calibration assumes a sine-wave signal, and that under actual program material of

Panel, the outgoing channel amplifier, the line amplifier at the transmitter, and the final result; monitoring of percentage modulation of the transmitter. The duties of the control operator include not only the switching of studios and lines on scheduled time or cue words, and proper mixing of voice and music on studio set-ups, but also to make certain that his reference-volume, or zero volume level does not exceed that point to which 100-percent modulation of the transmitter is referred. "Zero volume" level is simply an arbitrary point and is not to be thought of as rigid fundamental electrical units of power, current or voltage. It is





**Fig. 4. Over-modulation of negative peaks will cause excess energy to be radiated in spurious frequencies.**

cannot be expected to agree, even with perfectly matched circuits in between.

### True and False Readings

This one fact is probably the most universal reason for friction between transmitter and studio personnel. It is not possible, for instance, to obtain the same polarity of maximum energy from the two sides of a bi-directional microphone. An interviewer may show an indication at the transmitter of 100-percent modulation, the interviewee on the opposite side of the microphone (therefore oppositely poled at the microphone transformer) show only 50 percent (or less), yet the indicator at the studio, (full-wave rectification) will show exactly the same peak level.

It is perfectly plausible then, that the transmitter operator unfamiliar with speech-wave characteristics

through a microphone, should conclude from his monitor reading that the two voices are not balanced at the studio end. This belief is sometimes further encouraged by the extreme difference of "loudness sensation" between two voices of different timbre that are peaked the same amount on a full-wave rectifier indicator. This discrepancy between level indication on a meter and the aural "on air" level is one of the most perplexing difficulties of broadcasting and will be taken up in more detail later.

The above discussion brings to mind several questions as to transmitter operating technique: Is there any true indication at the transmitter of incoming level from the studio? Which pole of the modulation envelope should be monitored continuously and why?

In arriving at an answer to the first question, we have seen why conventional monitoring of a single pole of modulation eliminates that meter as a true indication of comparative levels from the studio. Certainly the *vi* on the output of a compression amplifier would not be a true indication, since the compression circuit starts functioning at a predetermined level and compresses each additional 10 db of input to an output increase of only 1 db. The compression meter, however, indicating the amount of compression taking place from a full-wave compression control rectifier will give the most accurate check on level from the studio (within limits due to characteristics of wire transmission, and difference of dynamic characteristics). Thus it may be understood by the transmitter operator why the compression meter may at times indicate the full amount of db

limiting occurring, yet modulation of a single peak on the modulation meter may indicate only 30 to 40 percent.

There can be no stronger argument than this for the need of a full-wave rectifier for the indication of mean percentage of modulation, as well as monitoring of the separate positive and negative poles. There seems to be very few stations at the present time utilizing such a method of checking the percentage of modulation.

### Modulation Peaks

The question as to which peak should be the most important to hold under 100 percent is quickly answered by ob-

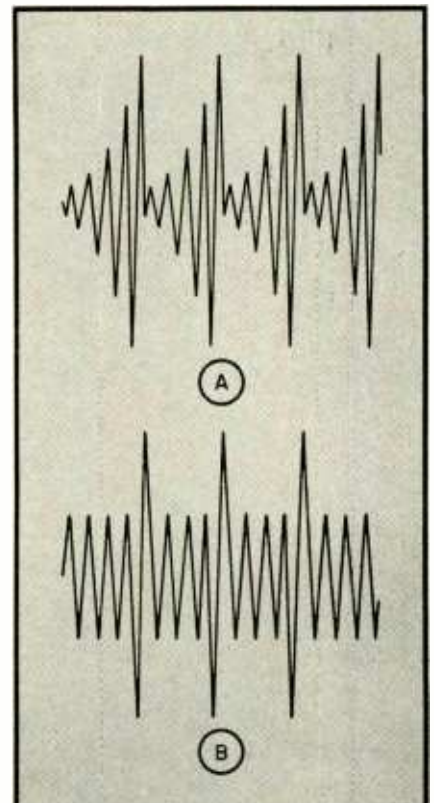

**Fig. 6. Graphical integration from an actual oscillograph of two male voices intoning the same vowel (ah) at the same frequency.**

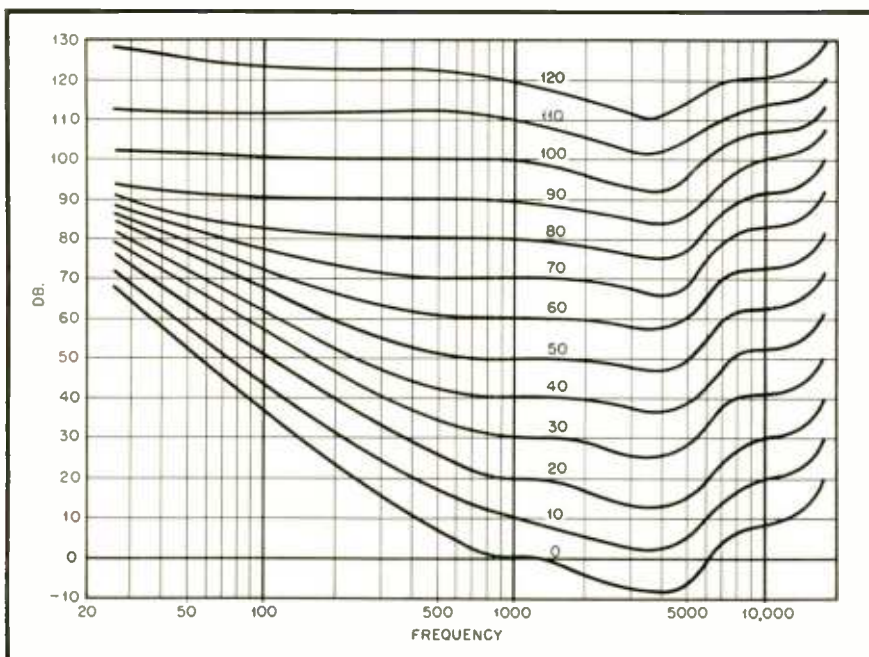

**Fig. 5. Loudness level curves as adopted by the American Standards Association.**

serving Fig. 4. It is seen that negative peaks cannot reach over 100 percent of the available range, thus making obvious that "over-modulation" of the negative peaks will cause this excess energy to be radiated in spurious frequencies, resulting in distortion and adjacent channel interference.

A cathode-ray oscilloscope is invaluable for monitoring purposes, since negative peak clipping is readily observed by the "string of sausage" effect through the center of the modulated envelope. Overmodulation on the positive

[Continued on page 56]

# VOLUME EXPANSION

## BY NEGATIVE DEFINITION

G. E. OTIS

★ The function of a volume expander circuit in audio application is to vary the gain of an amplifier directly with the input signal voltage. Thus, as the input signal voltage,  $e_s$ , increases in amplitude, the gain of the amplifier,  $M$ , also increases. In this manner loud musical passages receive greater amplification than do softer passages, and the dynamic response of the amplifier is greatly increased.

### Negative Definition

The function of a volume expander

may be stated in a negative sense by saying that the gain of an amplifier is made to decrease as the input signal voltage decreases. The inference drawn from the positive definition as stated in the preceding paragraph is that the gain of the amplifier will increase from some minimum point of gain,  $M = k$ , to an unlimited maximum,  $M \rightarrow \infty$ . The negative definition infers that the gain of the amplifier decreases from some maximum point  $M = K$ , to a minimum value of  $M \rightarrow 0$ .

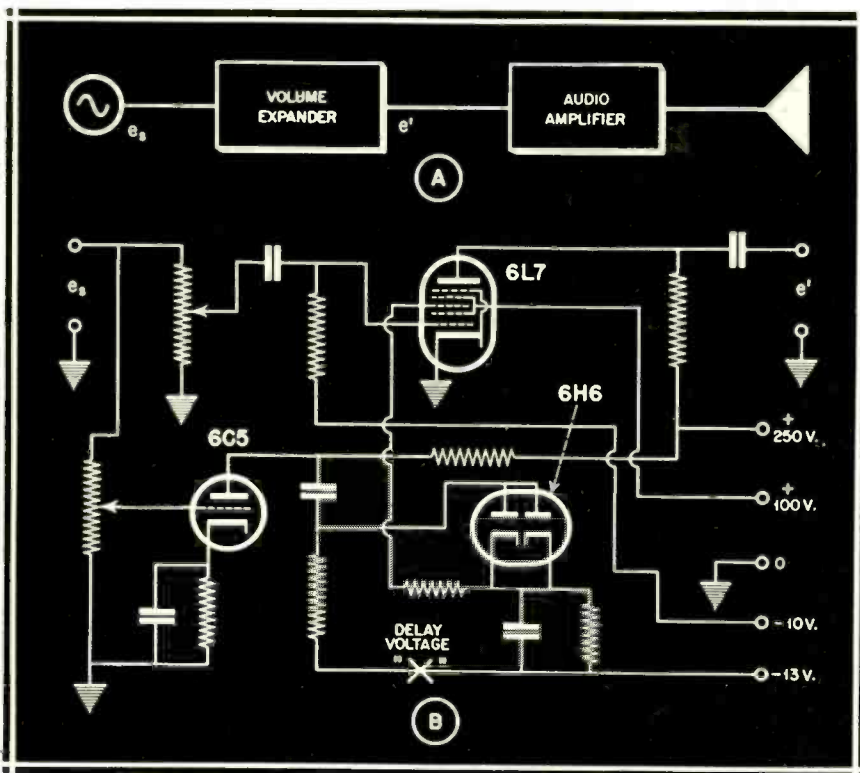

Fig. 1. Block diagram and schematic of widely-used expander.

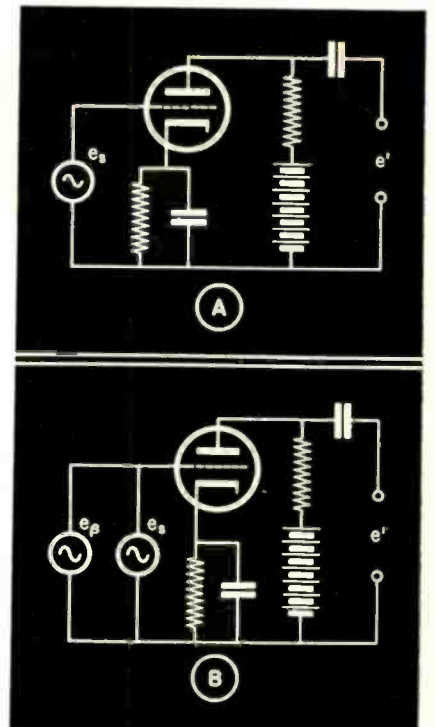

Fig. 2. A—Voltage amplifier. B—Amplifier with secondary voltage applied.

Fig. 1-A shows a block diagram of an expander-amplifier arrangement in the positive sense of the definition. It will be noticed that expansion is accomplished before main amplification takes place. A circuit diagram of a widely used volume expander is illustrated in Fig. 1-B.

An examination of Fig. 1-B will show that the gain of the 6L7 stage equals:

$$M = \mu k \quad (1)$$

where  $k$  represents the circuit constants  
 $\mu$  is a direct function of  $e_s$ .

From equation 1 it follows that  $M \propto$



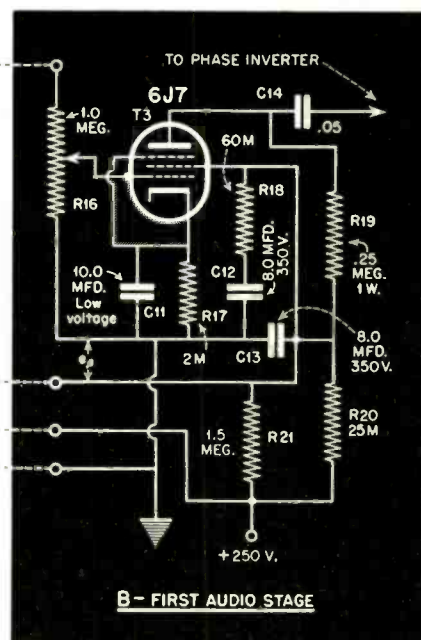
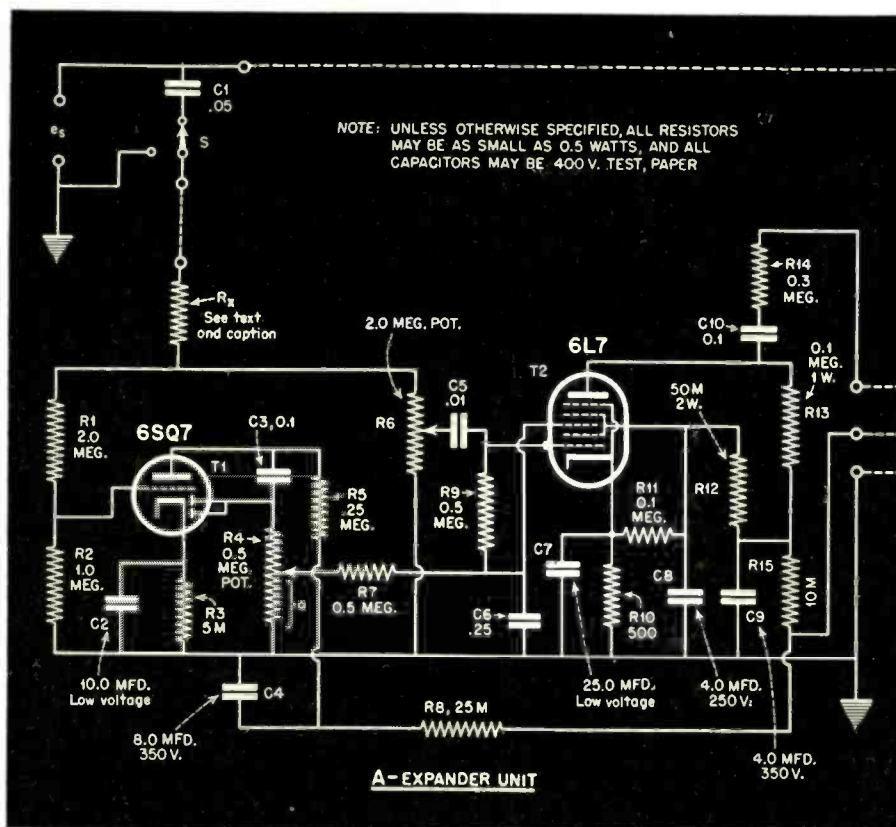

Fig. 3. Load presented to phono pickup when  $R_X=0$  is 0.3 meg. minimum and 0.65 meg. maximum. If  $R_X=1$  meg., the minimum load is 0.58 meg. and 0.75 meg. maximum.  $C_7$  should not be eliminated since distortion of the signal  $e_{\beta}$  will result.

$f(e_s)$ , satisfying the positive definition of volume expansion.

Further examination of Fig. 1-B\* will show the possibility of distortion with even comparatively small values of input voltage, and it will be noted that the first audio amplifier stage must be capable of handling a wide range of input voltage,  $e'$ . A well-designed power supply is necessary for proper expansion results.

If a similar circuit were used in a negative sense, i. e.,  $M \propto 1/f(e_s)$ , volume compression would result, and the voltage  $e'$  would tend to remain constant as the amplitude of the input signal voltage,  $e_s$ , varied. Circuits of this type are widely used in broadcast and microphone work.

### Negative Condition

It is possible to obtain conditions to satisfy the negative definition of volume expansion, however. Let us assume an ordinary voltage amplifier stage as shown in Fig. 2-A. Here the output voltage,  $e'$ , will equal:

$$e' = \mu \cdot e_s \cdot c \quad (2)$$

where  $c$  equals the circuit constants and  $e_s$  equals the input signal voltage.

Suppose that another signal voltage  $e_{\beta}$ , of the same frequency and in phase

\* The circuit illustrated in Fig. 1-B is fully described in the R.C.A. Receiving Tube Manual to which the reader may refer. Reference to the section on inverse feedback in the same publication might prove helpful in understanding the effect of  $e_{\beta}$  on  $e_s$  mentioned later in the article.

with  $e_s$  were applied simultaneously to the grid of the tube together with the original signal,  $e_s$ , as shown in Fig. 2-B. The output voltage  $e'$  will now equal:

$$e' = \mu \cdot (e_s + e_{\beta}) \cdot c \quad (3)$$

If  $e_{\beta}$  were a voltage smaller than  $e_s$ , and of the same frequency but 180 degrees out of phase with  $e_s$ , equation 3 could be then written:

$$e' = \mu \cdot (e_s - e_{\beta}) \cdot c \quad (4)$$

The gain of the stage will now equal:

$$M = \frac{\mu \cdot (e_s - e_{\beta}) \cdot c}{e_s} \quad (5)$$

or if we let  $e_t$  equal the effective input voltage,  $(e_s - e_{\beta})$ :

$$M = \frac{e_t}{e_s} \quad (6)$$

Should  $e_{\beta}$  be made to vary inversely with  $e_s$ , than as  $e_s$  increases in amplitude,  $e_t$  will approach a maximum value of  $e_s$ , since  $e_{\beta}$  will approach zero. Also, as  $e_s$  decreases,  $e_t$  will approach a minimum value of zero, since  $e_{\beta}$  will increase and approach  $e_s$  in value. Under these conditions the negative definition of volume expansion is satisfied, and the gain of the stage becomes a direct function of  $e_s$ .

### Obtaining Secondary Voltage

The method for obtaining the signal voltage  $e_{\beta}$  as an inversely varying function of  $e_s$  is illustrated in Fig. 3-A. The circuit is simple, employing one dual-purpose tube,  $T_1$ , and one vari-

able-mu tube,  $T_2$ . As is indicated, the power supply of the amplifier to which the expander unit is attached supplies the plate voltage for the unit. To minimize the possibilities of regeneration through the use of a common power source, the plate circuits of  $T_1$  and  $T_2$  are equipped with decoupling filters.

From an examination of Fig. 3-A it is apparent that in reality the expander unit is a compressor circuit. A portion of the input voltage,  $e_s$ , is amplified by the triode section of  $T_1$ , and the amplified voltage is applied through the capacitor  $C_3$  to the diode plates for rectification. The varying d.c. voltage appearing across the diode load potentiometer,  $R_4$ , supplies the negative bias voltage for grids 1 and 3 of the variable-mu tube,  $T_2$ . As  $e_s$  increases, the negative bias applied to the two control grids of  $T_2$  increases with a resulting decrease in the value of the mu of  $T_2$ . Thus, the mu of  $T_2$  becomes an inverse function of  $e_s$ .

A portion of the input voltage,  $e_s$ , is also applied to grid 1 of  $T_2$  through the potentiometer  $R_6$ , and is amplified by  $T_2$  appearing 180 degrees out of phase with  $e_s$  in the plate circuit of  $T_2$ . Since the mu of the tube  $T_2$ , is an inverse function of  $e_s$  as described in the preceding paragraph, the voltage in the plate circuit of  $T_2$  becomes the desired signal voltage  $e_{\beta}$  required to satisfy equation 6 for volume expansion by negative definition.

[Continued on page 59]

# RADIO WEATHER FORECASTING

PVT. PERRY FERRELL, JR.

U. S. Army Signal Corps\*

## The Determination of the Movement of Air Masses by Variations in U.H.F. Signals

### Abstract

★ The propagation of u.h.f. signals beyond the diffractive horizon is accomplished by the passage of the wave-train from one medium to another. As this refraction takes place at a specific geographical location it is possible, when noting the strength variations on several azimuths leading from the receiving position, to plot the approximate location of the wave bending front. Using complimentary meteorological data, it becomes practicable to forecast the incursion of a new air mass into the observers' vicinity.

### Air Mass

★ During the past six years several researchers have attempted to correlate the various weather phenomena with ultra-high frequency reception. (See references at end of article.) These accumulated studies formed the present theory of tropospheric air mass boundary bending (also known as "extended ground wave," "lower atmosphere bending," "T.A.B.B.," "refractive propagation," and "pre-skip bending") which has been resolved to a fine degree. Behind the increases in field strength of medium-range stations and the appearances in receiver backgrounds of signals far beyond the quasi-optical, is the constant fluid movement of individual air masses in the ocean of air surrounding us. The boundaries between different types of air masses—these "Fronts" as they are popularly known—account for the refraction of u.h.f. signals beyond the normal diffractive horizon.<sup>1, 5, 6, 9, 10</sup>

\* This paper does not reflect the opinion of, nor constitute a verification by the U. S. Army Signal Corps.

Pre-war 56-mc experimenters and amateurs found that after reviewing the few works on the correlation of air-mass movement with u.h.f. reception<sup>4, 5</sup>, it was practicable under ideal circumstances to undertake a prediction of future DX reception from the daily weather map. Unfortunately, such predictions were extremely long range for inexperienced forecasters, and therefore, were subject to wide inaccuracies, and could only be classified as poor at best. Today we still have weather—whether or not we have reports or maps, and we also have an immense number of u.h.f. stations (30 to 120 mc) of all services which, when applied to the hypothesis outlined below, can provide an accurate 12- to 36-hour forecast of changing weather conditions. By virtue of received field-strength variations and the incursion of a "polar" or "tropical" air mass into the receiving radius (100-300 miles), it will be possible to judge the severity of the change and to plot the advancing course of the new front.

### Theory

Refraction of u.h.f. signals in the troposphere is directly proportional to the varying index of refraction with height. In the normal (stabilized air mass) troposphere the temperature gradient and index of refraction decreases nominally with height, but at such a high rate that it is natural for radio wavefronts at near tangential path angles of 3 to 5 degrees to be bent earthward. Physically, this is explained by the increase in phase velocity of the upper portion of the wave-train being slightly greater than the

relative phase velocity of the lower portion. This compensation barely increases the quasi-optical signal range more than one-third. During intervals when an inverse temperature gradient exists, the refractive index increases, because fundamentally the signal is passing between two media, or in this instance, between a warm and a cool air mass. This pre-skip path may be entirely above or partially below the diffractive horizon, and will depend (inter-alia, resultant field strength) upon upper air temperature, relative humidity, and the flowing individualistic movement of air masses.

Fading type, extent and character of u.h.f. signals, represents a very important part in this study. This fading is due specifically to the mixture of diffracted and refracted paths† and the consequential phasing. One may be inclined to believe that the diffractive path (true ground wave) is of little importance over the long distances that are encountered in this study. If this were true, however, and refraction was the only factor in 75-300 mile propagation, (assuming the diffractive signal ceases abruptly at the four-third earth radii horizon) then under frequent conditions there would be a distance, or span, at which the field strength would suddenly drop to zero—the inner and outer refractive horizons (skip). This very seldom happens as the observer may note the continuous presence of fading signals thousands of feet below the diffractive horizon.

Under these circumstances refractive propagation is not rectilinear propagation<sup>10</sup>, and in many instances signals will follow not only a concave vertical path, but will also be refracted at an oblique horizontal angle (see Fig. 1—path K-4 to G-7, via point B-F in

† The term "refracted path" is often erroneously referred to as the "incident reflected path," particularly in earlier works.



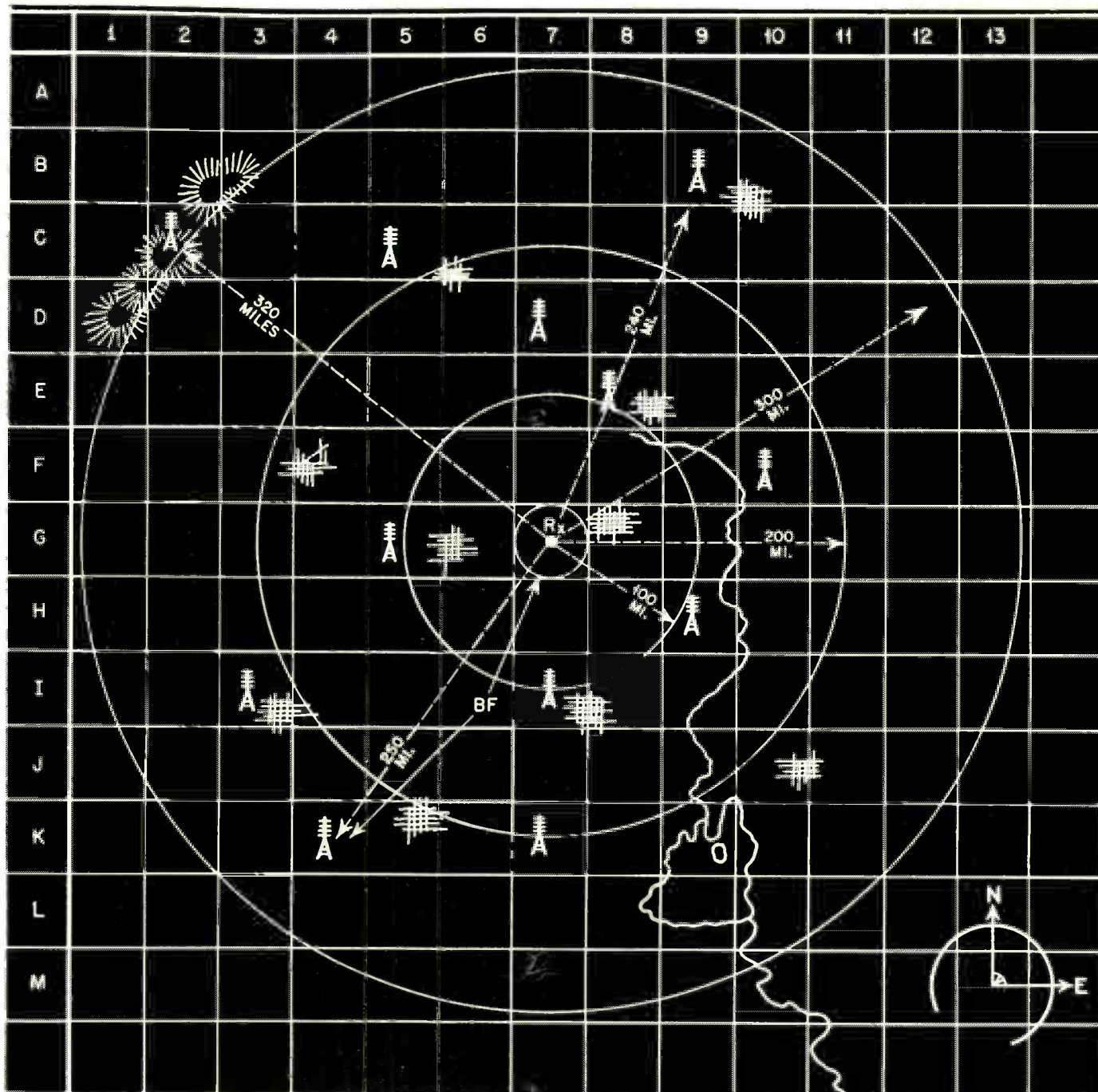

Fig. 1. Hypothetical map encompassing a number of u.h.f. transmitters operating on various frequencies, the signals from which are intercepted at a fixed point of observation.

1-6). The possibility of multi-lateral paths as well as multi-vertical paths further increases the overall effect of minor bending fronts and extends the sensitivity of this hypothesis.

The propagation of u.h.f. signals beyond the four-third earth radii diffractive horizon is accomplished by the passage of the wave group from one medium to another. As this refraction will occur under suitable conditions at a very specific geographical point, it should be possible when noting the signal strength variations on several azimuths, leading from the observer's receiver, to plot the approximate location

of the principal bending front, as well as its course and advancing or retiring rate of speed. This is a complimentary correlation with meteorological phenomena and thus it is practicable to forecast the incursion of a new air mass, or change of weather into the observers' vicinity.

#### Types of Air Mass

Weather phenomena, until a little over a decade ago, was a shallow, obviously mysterious subject that apparently defied logical explanation. Shortly before the first notation of "extended ground wave" was applied to

weather analysis by Ross Hull<sup>6,7</sup>, a physicist named Vilhelm Bjerknes, of Norway, published a scientific classic which pictured weather in such great detail that the invaluable theory of air mass movement was formed. While this subject is immensely interesting as it pertains to our everyday life, it is the only necessary requisite of this paper, to distinguish between different types of air masses and refer those who may be interested to the writings of C. F. Brooks and Wolfgang Lange-wiesche for a more complete study of the air-mass theory.

In the jargon of the meteorologist

— to use common terminology — a Tropical Gulf air mass would be indicative of that warm moist air brewed in the Caribbean by the constant roving thunderstorms that carry the heat and moisture aloft. In the winter it moves northward as a steady gray, low, unbroken overcast with a shivering drizzle. In the summer it is hot, steamy, and sultry—typical midsummer weather. Tropical Atlantic, a namesake striking from the Southeast and East, often appears as fog banks along the coast and patchy ground fog in the lowlands. Out of the equatorial Pa-

Of particular importance to refractive propagation is the Superior air mass. It probably comes from the tropics, maybe from somewhere above the Galápagos Islands, but every so often it drops down to the surface as a hot, clear and extremely dry mass. A few instances of unaccountable long-distance bending can often be traced to this Sec Superieur air mass lying thousands of feet overhead.

#### Treatment of Typical Cases

In our imaginary cases (which are necessitated by wartime censorship re-

scales. Plot in about eight squares on all azimuths from the receiving position, and mark in all important transmitters, frequencies, schedules and whether the station can be heard with diffractive propagation during a polar air mass. Take particular note of those stations from the south-west-north directions as most air masses advance as influenced by the Coriolis Force of the northern hemisphere.

Early one hazy morning a weak signal carrier is heard on the channel of the experimental station in C-2, and G-7's interest is immediately aroused. At the time of this reception G-7 and surrounding area are encompassed by a true tropical gulf air mass. It is the steamy, oppressive heat of midsummer with only slight occasional southerly winds that have people talking of the humidity, and relief.

There is a distinction between mass weather and local weather noteworthy here; i.e., what is known as local weather will be undergoing minor changes within the mass itself. There is a daily cycle of weather, clouds, minor temperature changes, perhaps even short evening thunderstorms, or showers in some sections, but, essentially the true weather is the same, day in and day out; sticky, hot, and dull. In the same vein all u.h.f. signals will be undergoing diurnal peaks in early mornings and evenings, the result of convective bending. Such signals will be up in strength and accompanied by slow rollers (*Fig. 2*) while the station in C-2 would be inaudible except for short sporadic peaks<sup>9</sup>.

Within the half-hour of the first reception, the wild scintillating fade as caused by turbulent air at a near vertical bending boundary is heard on the weak carrier. A new air mass is entering the vicinity with its leading edge directly overhead at C-2 (see *Fig. 3*). As two hours pass, a peak in carrier strength from C-2 is reached — the scintillating fade has slowed down to a surprisingly steady, extremely slow rate swing.<sup>9, 11</sup> This is a verification that the mass is Polar Canadian air and is moving into this vicinity—Polar Canadian air, bringing mid-summer relief with gentle to mild northwesterly winds and numerous small hurrying clouds. The air of good visibility and moderate summer showers, whose leading edge we can predict is moving towards us at about 15 to 25 miles per hour.

With the data evolved from the reception of this one station, G-7 may predict a severe short thunderstorm followed by clearing and cooler weather in about 15 hours from the first observation. Bearing with this forecast, G-7, by chance intercepted an afternoon test transmission from the tele-

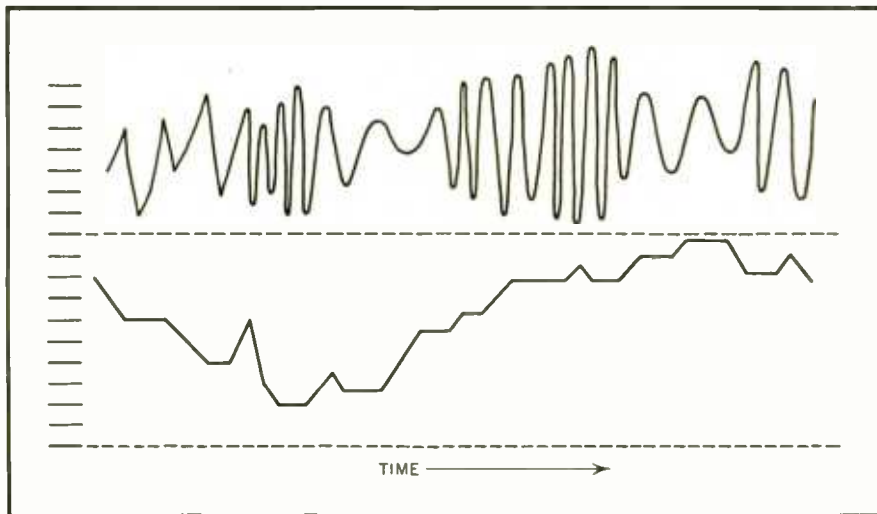

**Fig. 2. Approximations of a typical slow rolling fade (above) and a scintillating fade. The variations are proportional to average field strength.**

cific—in fact the South Sea Islands—comes the Tropical Pacific air mass as clear and blue as a continuous summer day. Sweeping up from northern Mexico and the southwestern deserts is the extremely dry and scorchingly hot air mass of the Tropical Continental. It is the originator of the Oklahoma dust bowl.

As counterparts are the important Polar Canadian airs which are conditioned from Columbia to Hudson's Bay to Labrador—all ice cold, clear and dry. In the summer Canadian air is mild, extremely clear and frequented by high fluffy cumulus clouds. It is still lively, but not to compare with the driving snow or rain squalls of mid-winter. From off the coast of Newfoundland comes the Polar Atlantic mass—a calm, stable sort, until aroused into a "Northeaster" with gales, low unbroken clouds and cold rains.

Polar Pacific strikes generally in the northwestern corner of the states as a very moist, cool, high fog after a long journey from the Steppes of Siberia. Condensing in the Sierras and Cascades it moves into the Dakotas as a dry, hot wind, often known as a Chinook.

restrictions) it will be possible to see the same effects as might be obtained at various locations throughout the mid-western and eastern portions of the continent. Plotting G-7 in *Fig. 1* is our supposed receiving position. Equipment there will cover 30 to 120 mc, and an FM receiver with a limited grid current meter reading nominal field strength variations is also provided.

New FM commercial broadcast stations in plots G-5, B-9, D-7 and K-4 are the real backbone of G-7's study, because of their hours of operation and long-range locations. Some 320 miles to the northwest, in plot C-2 is an experimental 45-mc broadcast transmitter located on a mountain-top which tests daily. In E-8 is a 500-watt non-commercial educational broadcast station which is on the air weekday afternoons. In K-7, I-3 and I-7 are police transmitters using the 37.1-mc channel, and on 37.54 mc are the forestry service stations of F-10 and H-9. Plot C-5 completes the picture with a 55.75-mc sound television transmitter in a very bad location and using low power.

Similarly experimenters may plot a rectangular coordinate about their own locations using forty-mile square



vision station in C-5—eight hours elapsed and C-2 was rapidly dropping out at sign-off time.

Before two hours had slipped by, simultaneous erratic swings were noted on both G-5 and D-7, and G-7 knew the front stretched from K-1 to A-9. As the time signal boomed out from I-3 and the scintillating fade intersected B-9, the sky overhead at G-7 underwent several marked changes. The big fluffy cumulus became a little more numerous and a very definite south wind casts them into odd shapes that pile higher and higher. Then as the familiar fade strikes the E-8 path an ominous dark cloud bank approaches G-7 from out of the northwest. It has long since grown dusk and here comes the actual leading edge. In the next hour as the front arrives and lightning streaks across the sky, there is a cloudburst and amid this and the strong gusts of wind, B-9 is heard with a terrific signal as G-5 and D-7 slowly drop in strength.

Then as the frontal weather passes the rain ceases, the clouds break, and the stars can again be seen in the cool, clear night air. By u.h.f. reception it was possible to predict this new polar air mass, or weather, 15 hours before its arrival.

### Air Mass

As the polar air mass settles comfortably about G-7 any real change in the weather now will be the result of an incursion of a tropical mass.

There is actually a good repetitive sequence in this action if we picture the lower portion of the atmosphere as an even-depth lake in which the liquid is the elastic, thin, light fluid—air.ery

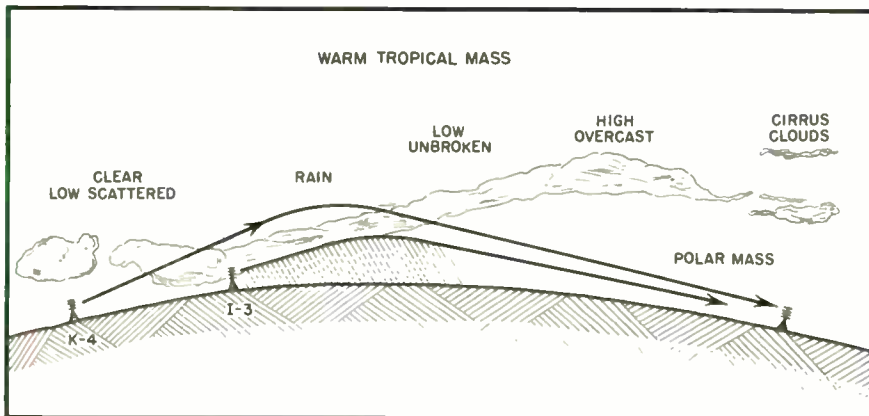

Fig. 4. A warm air mass moves slowly northward. K-4 is well up in strength and I-3 can be heard with a rolling fade. The weather passes G-7 in the sequence illustrated.

When a polar mass surges violently southward it may reach far into the equatorial belt, and as we now watch the rhythmical swell of the tropical backswing it is well to keep in mind that this northward surge is a manifestation of our polar incursion.

If during the Fall, G-7 were to return home late one cool evening and notice a halo about the full moon—which meteorology explains as the refraction of lunar reflected light by ice crystals 20,000 to 25,000 feet above the surface—he might ponder if this were not a leading edge of a tropical air mass.

Tuning the police frequency at the hourly time signal from I-3 and I-7, G-7 can notice no accountable change in apparent strength—but in the last five minutes before K-4 signs off, a sharply rolling fade has been introduced on that weak carrier. Though not definitely ascertained, there is ev-

indicating that Caribbean air is advancing from the South or Southwest.

The following morning the sun shines behind a high solid milky overcast (Fig. 4) and when K-4 returns to the air the signal strength is well up with a slow rolling fade. G-7 can now safely predict gathering clouds—rainy periods—fog, and heavy, low clouds with rain within 45 to 50 hours.

The sequence now is relatively simple as K-4 steadily increases in strength during the day that has grown dark due to the dull, gray, high unbroken overcast. That second evening K-7, I-3 and I-7 can be heard with definite gains, and on the second morning K-4 has a particularly strong signal during the patchy ground fog and low unbroken clouds that overhang G-7.

Two days later G-7 has a period of heavy rain followed by gradually clearing weather, much warmer and even slightly humid.

A weather cycle has been completed, and it is now time to turn our attention northward to catch the next phase and predict it by u.h.f. reception.

### REFERENCES

- 1—Ultra-Short Wave Transmission and Atmospheric Irregularities—Englund, Crawford and Mumford—*B.S.T.J.*, Vol. 17, October, 1938, page 489.
- 2—Ultra-Short Wave Propagation—Schleng, Burrows and Ferrell—*Proceedings IRE*, Vol. 21, March, 1933, pages 427-463.
- 3—Some Results of a Study of Ultra-Short Wave Transmission Phenomena—Englund, Crawford and Mumford—*Proceedings IRE*, Vol. 21, March, 1933, pages 464-492.
- 4—Ultra-Short Wave Transmission Over a 39 Mile Optical Path—Englund, Crawford and Mumford—*Proceedings IRE*, Vol. 28, August, 1940, page 360.
- 5—U.H.F. and the Weather—M. S. Wilson—*Radio*, January, 1940, page 33.
- 6—Air Mass Conditions and the Bending of U.H.F. Waves—Ross Hull—*QST*, Vol. 19, June, 1935, page 13.
- 7—Air Wave Bending of Ultra-High Frequency Waves—Ross Hull—*QST*, Vol. 21, May, 1937, page 16.

[Continued on page 55]

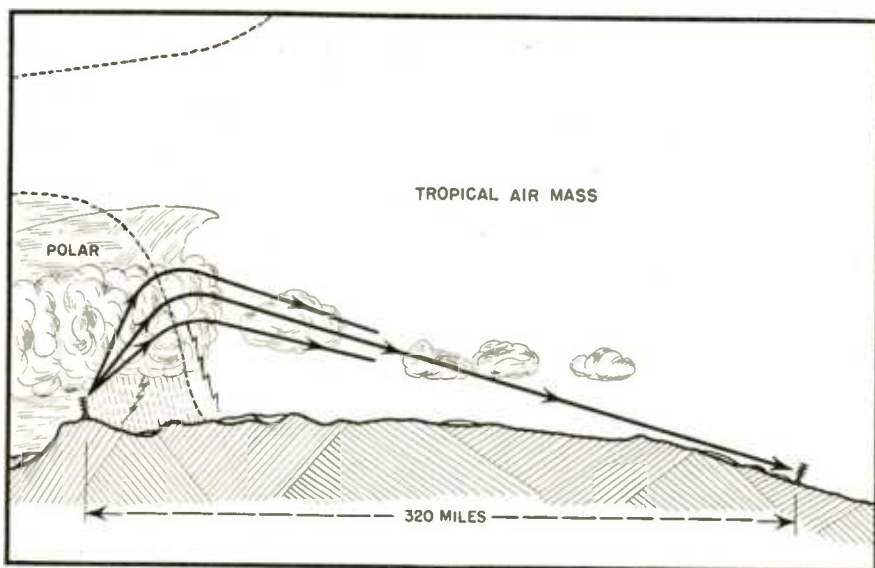

Fig. 3. The refraction of u.h.f. signal by discontinuities in the troposphere, in this case between a Polar Canadian and a Tropical Gulf air mass. Bending at this near vertical front would result in extreme phasing as the turbulent air would produce scintillating fading.

# RADIO-ELECTRONIC COMPONENTS

A. C. MATTHEWS

## PART 3—INDUCTORS

★ Many factors enter into the design of inductors for use at radio frequencies. Any good text on radio engineering covers the fundamental design so this will not be considered here. Rather we will discuss such points as distributed capacity, skin effect, Q and other factors which contribute to stability under adverse temperature and humidity conditions.

### Distributed Capacity

The voltage drop between terminals of an inductor is the sum of all the drops of voltage between turns. Since any two turns have a difference of potential between them, they act as the

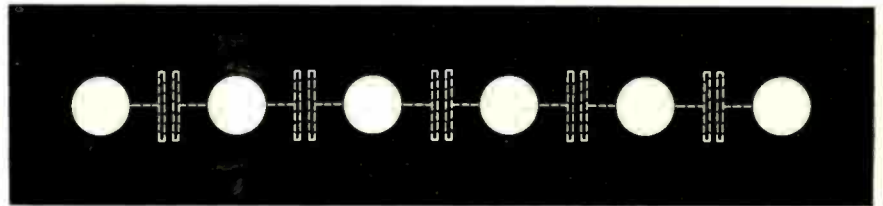

Fig. 14. Distributed capacity between coil turns.

two plates of a capacitor. This capacity is distributed throughout the length of the coil as shown in Fig. 14. In the ordinary multi-layer coil the potential difference between the first turn of one layer and the last turn of the next layer is much larger than the voltage between adjacent turns in the same layer.

This appreciably increases the distributed capacity. In order to reduce the distributed capacity, coils wound as shown in Fig. 15 are often employed.

The bank winding is arranged so that consecutive turns are not adjacent to one another, thereby decreasing the distributed capacity. The universal or

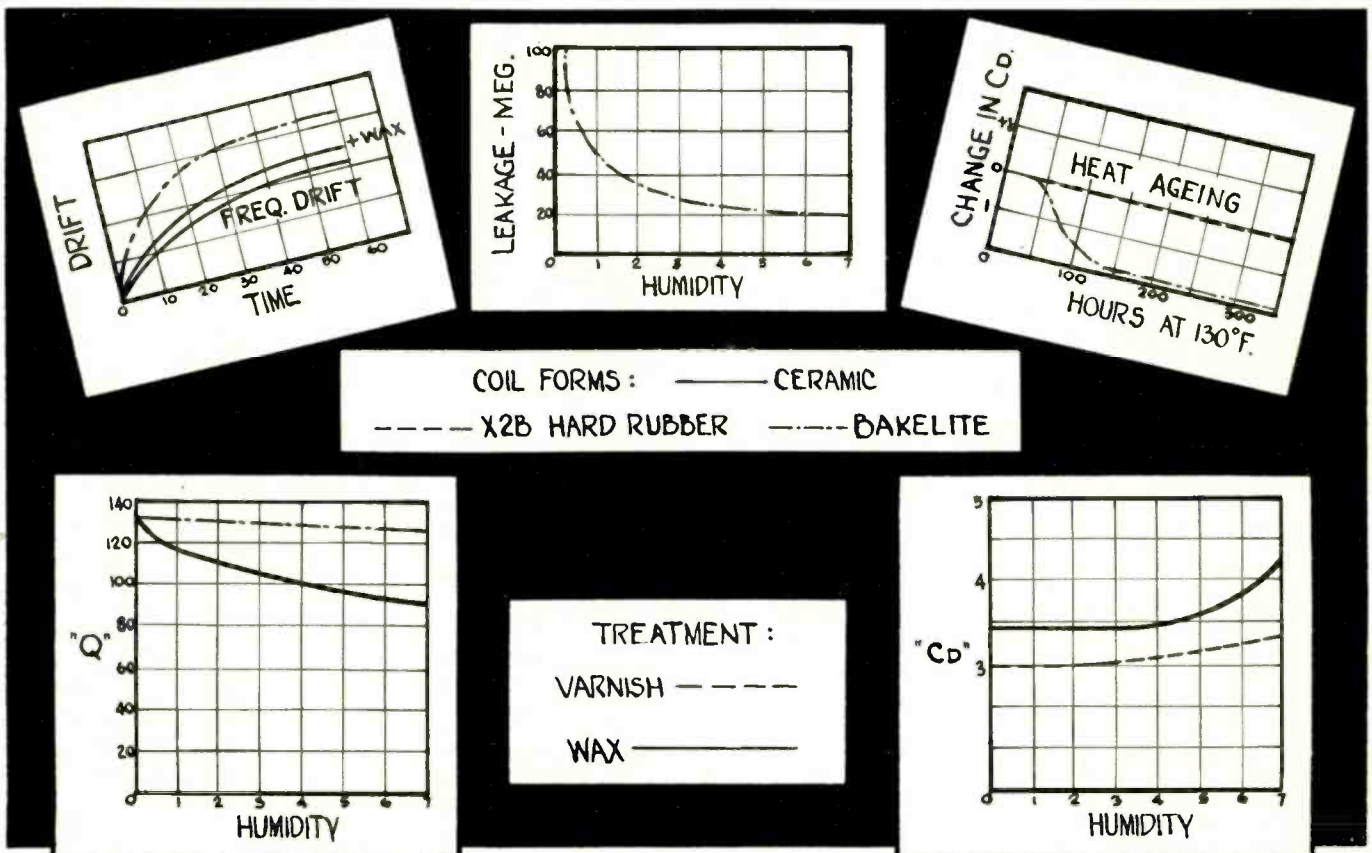

Fig. 16. Heat-humidity characteristics of r-f coils.



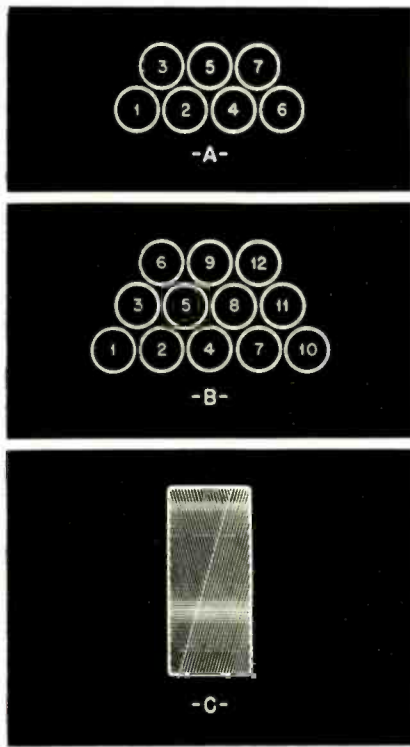

Fig. 15. A—Two-layer bank. B—Three-layer bank. C—Universal or honeycomb.

“honeycomb” coil is wound with a space between adjacent turns and arranged so that the wires of one layer cross those of the preceding layer at an angle, thus reducing the area of contact and consequently lowering the capacity.

The effect of distributed capacity is ordinarily negligible at low frequencies but at radio frequencies it must be considered. Effectively the coil behaves as a true inductance with a small capacity shunted across its terminals. Thus it will have a natural resonant frequency of its own. In addition to this, the distributed capacity will increase the losses due to the solid dielectric in the electrostatic field between turns. For this reason grooved coil forms are not advisable above 10 megacycles. However, enamel insulation may be employed with a resultant loss in  $Q$  of approximately 5 percent at 18 megacycles. The magnitude of the loss will depend upon the quality and quantity of the insulating material employed, especially under conditions of high humidity. It is advisable to impregnate the coil to exclude moisture. The impregnating material should have a low dielectric constant. Waxes are usually satisfactory although they tend to volatilize with time. A polystyrene base varnish is particularly suitable and when properly applied and treated will eliminate aging and at the same time exclude moisture.

### Skin Effect

The variation of the resistance of

an inductor as a function of frequency is known as skin effect and is caused by a non-uniform current density distribution throughout the cross section of the conductor. This phenomenon causes the radio-frequency current to penetrate the conductor to a depth inversely proportional to the square root of the frequency, and when the conductor radius is greater than the skin-depth the material beyond the current-carrying layer has a negligible effect on the resistance. For copper the skin depth is  $0.000662 \times F_{mc}$  centimeters, which amounts to two mils at 1.75 mc, one mil at 7 mc and 0.13 mil at 400 mc.

This interesting property of r-f conductors makes possible copper or silver plating of a high-resistance metal of low thermal expansion, thereby obtaining low resistance plus a low or zero temperature coefficient of inductance. Copper or silver plating of such alloys is a common practice for use in resonant lines where excellent temperature stability is required. It is recommended that the plating be greater, by a safety

factor of two times, the figures given above.

### Figure of Merit ( $Q$ )

Tuned circuits are usually compared on a basis of their figure of merit, or “ $Q$ ”. Since the capacitor which resonates the coil to a desired frequency has a  $Q$  of many times that of the coil, it may be neglected for all practical purposes. We are therefore mainly interested in the  $Q$  of the coil. This is expressed as the ratio of the reactance to the resistance and can be represented by the equation,

$$Q = \frac{\omega L}{R}$$

where  $\omega = 2\pi \times$  frequency,  
 $R =$  resistance and  
 $L =$  inductance.

The resistance increases with frequency due to skin effect, distributed capacity between turns, eddy current losses in the conductor and metallic objects nearby, and dielectric losses. The magnitude of these losses is determined by the design, in particular; the dimen-

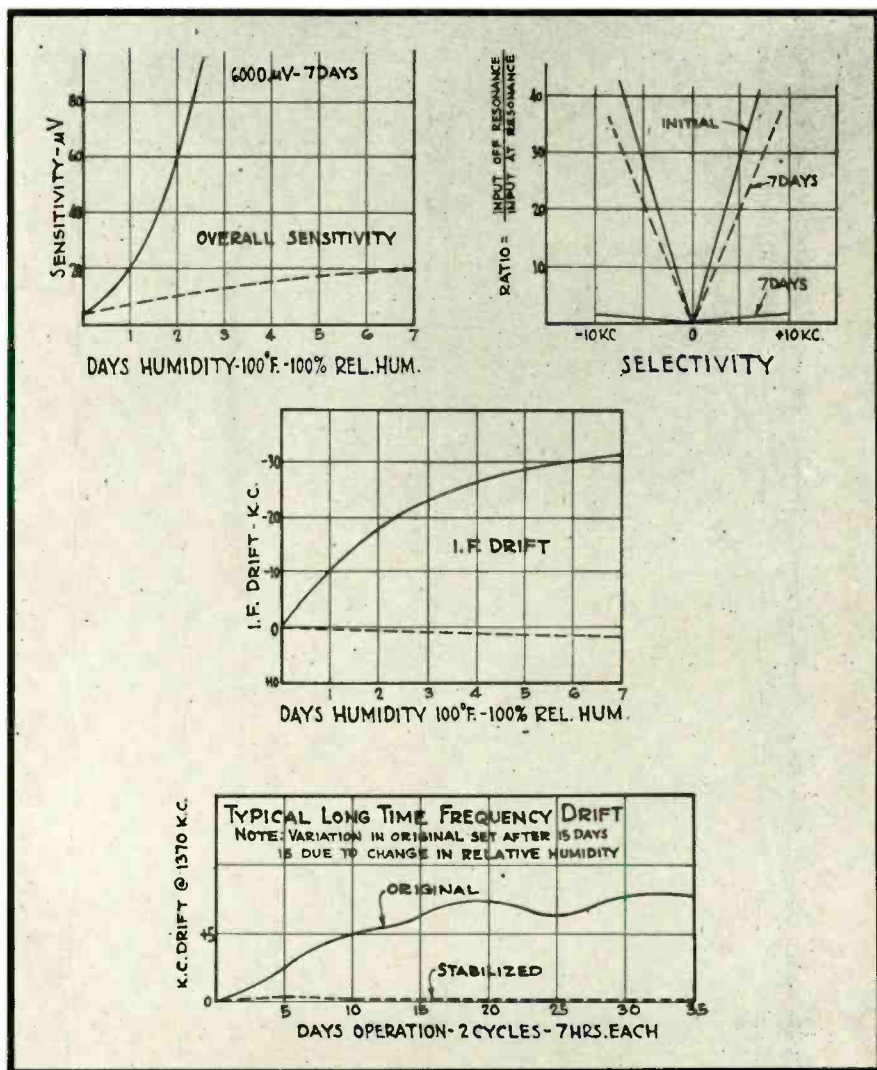

Fig. 17. Comparison of receiver sensitivity, selectivity, i-f and overall frequency drift using ordinary and specially treated components.

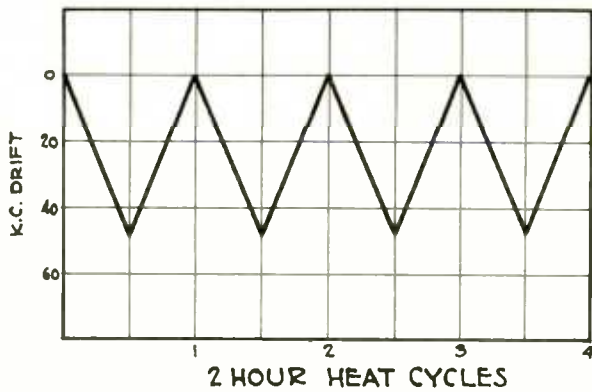
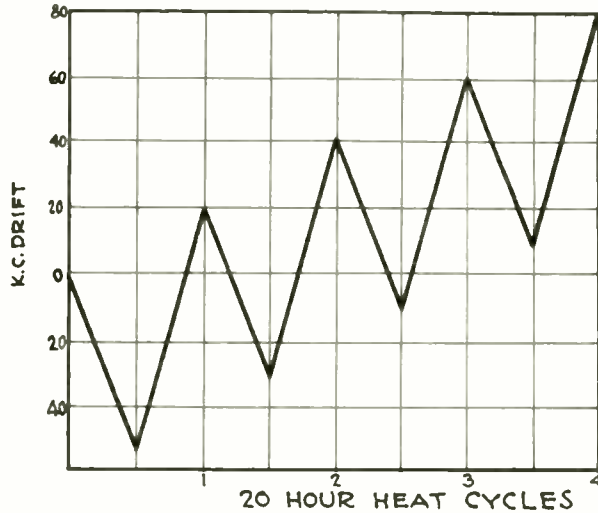

Fig. 18. Curves of typical oscillator drift, showing the effect of aging components. Curve at left covers 2-hour heat cycles; curve at bottom 20-hour heat cycles.

INITIAL  
OSCILLATOR  
FREQUENCY  
18 MC.



sions, wire size and material, winding form and shield, the problem being to effect a compromise between the losses so that the resultant resistance is a minimum.

Ordinarily the maximum dimensions are limited by the space available. This determines the maximum size of the coil. The diameter of the shield should be at least twice the diameter of the coil, with the ends separated at least the coil diameter from the top and bottom. Under these conditions the  $Q$  will not be reduced more than 8 percent.

The following equations have been checked experimentally by Pollack<sup>3</sup>:

$$\text{Length/diameter ratio} = 0.3 \text{ to } 0.5 \quad (4)$$

$$\text{Number of turns } N = \frac{\sqrt{L(102S + 45)}}{D} \quad (5)$$

$$\text{Optimum wire size } d_o = \frac{0.707b}{N} \quad (6)$$

(Note that the wire should be spaced so as to occupy approximately 0.7 of the total winding.)

The  $Q$  of a coil may be calculated (when it is not near its natural period in frequency) by the equation:

$$Q = \frac{\sqrt{fLdS^2D}}{31.62p(S^2D^2N + 2N^2d^2)} \quad (7)$$

<sup>3</sup> Design of Inductances—Pollack—*Electrical Engineering*, Sept. 1937.

#### Notation and Units—Equations 5, 6 and 7.

- $d$  = diameter of wire, centimeters
- $D$  = diameter of coil, centimeters
- $f$  = frequency, cycles per second
- $p$  = specific resistivity of conductor, in ohms per centimeter. For copper,  $p = 1.72 \times 10^{-9}$  ohms per centimeter
- $L$  = inductance, microhenrys
- $S$  = ratio of length to diameter of coil =  $b/l$
- $b$  = length of winding, centimeters

This equation takes into account the skin effect at high frequencies, but does not include dielectric or eddy current losses due to coil form, wire insulation or shield.

Typical coil characteristics under varying conditions of temperature and humidity are shown in Fig. 16. Note the comparative change between bakelite and ceramic forms with temperature, and the aging effect caused by volatilization of some of the ingredients in the bakelite. Note also the loss of  $Q$  versus days humidity with different impregnating materials.

#### Effect of Components on Receiver Performance

In order to illustrate the importance of component part design, we will use as an example measurements made on a typical broadcast superheterodyne receiver. The measurements were made at a temperature of 100° F. with a relative humidity of 98 percent, except for the overall frequency drift curves

which were made at normal room temperature and humidity.

In Fig. 17 is shown a comparison of receiver sensitivity, selectivity, i-f and overall frequency drift using ordinary and specially treated components. Note the tremendous loss in sensitivity with the ordinary components after two days of humidity. This was due primarily to frequency drift in the i-f amplifier which used compression type mica trimmer capacitors and an inadequate impregnation of the coils with a good grade of wax. From the curve of the i-f drift it can be seen how seriously moisture can affect the capacity of the mica dielectric type of trimmer.

The good curve was obtained by substituting an air trimmer and coils which had been properly impregnated in a polystyrene base varnish. Note also the difference in selectivity. Here the  $Q$  of the tuned circuits using specially treated parts remained nearly constant throughout the test while the ordinary parts gave practically no se-

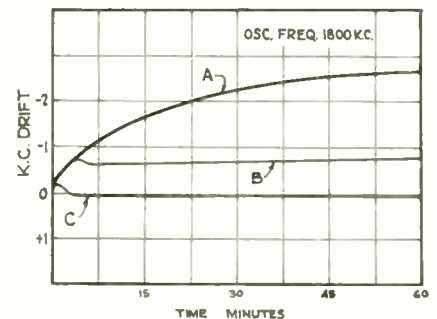

Fig. 19. Typical oscillator frequency compensation.

lectivity. The tuned circuit  $Q$  decreased to such an extent that the selectivity curve resembled that of an untuned amplifier.

Leakage of coupling capacitors in the r-f and a-f amplifiers was so great that the bias on the tubes were reduced nearly to zero. This increased the plate current to such an extent that the power supply was greatly overloaded. Proper impregnation of coupling capacitors, wire and terminal panels decreased the change as shown. Lengthening the leakage path between grid and plate connections or having a ground point between them will help considerably.

Fig. 18 shows the effect of aging components. Curves were taken under two types of operation. The first, where the receiver (without compensation to show the effect better) was operated for periods of two hours with a two-hour rest between measurements. The oscillator frequency is seen to drift less and less each cycle but the start-

[Continued on page 59]



# RADIO DESIGN WORKSHEET

No. 16—DETERMINING OPTICAL PATH; PHASE-MODULATED WAVE

## DETERMINING OPTICAL PATH

**Problem:** Determine the optical path between two points at heights  $H_1$  and  $H_2$  above a spherical earth, taking into account the effect of average refraction due to the decrease in dielectric constant of the earth's atmosphere with elevation above the surface.\*

**Solution:** In general the theoretical treatment of the propagation of quasi-

optical radio waves have been developed for idealized boundary conditions. If complex formulae are to be avoided, surface irregularities such as hills, buildings, trees, etc., must be ignored. Obviously such obstructions play an important part in propagation in actual practice.

For simplicity, reflections, either from the earth's surface or the upper atmosphere, will be neglected. Conse-

quently close agreement between practical and the assumed ideal conditions cannot be expected. Refraction causes a bending of the radio wave toward the surface of the earth. For our purposes it is sufficient to assume that this can be equivalent to an increase in the earth's diameter so that the optical path will be a straight line.

For computations of this sort, an average value of refraction or of in-

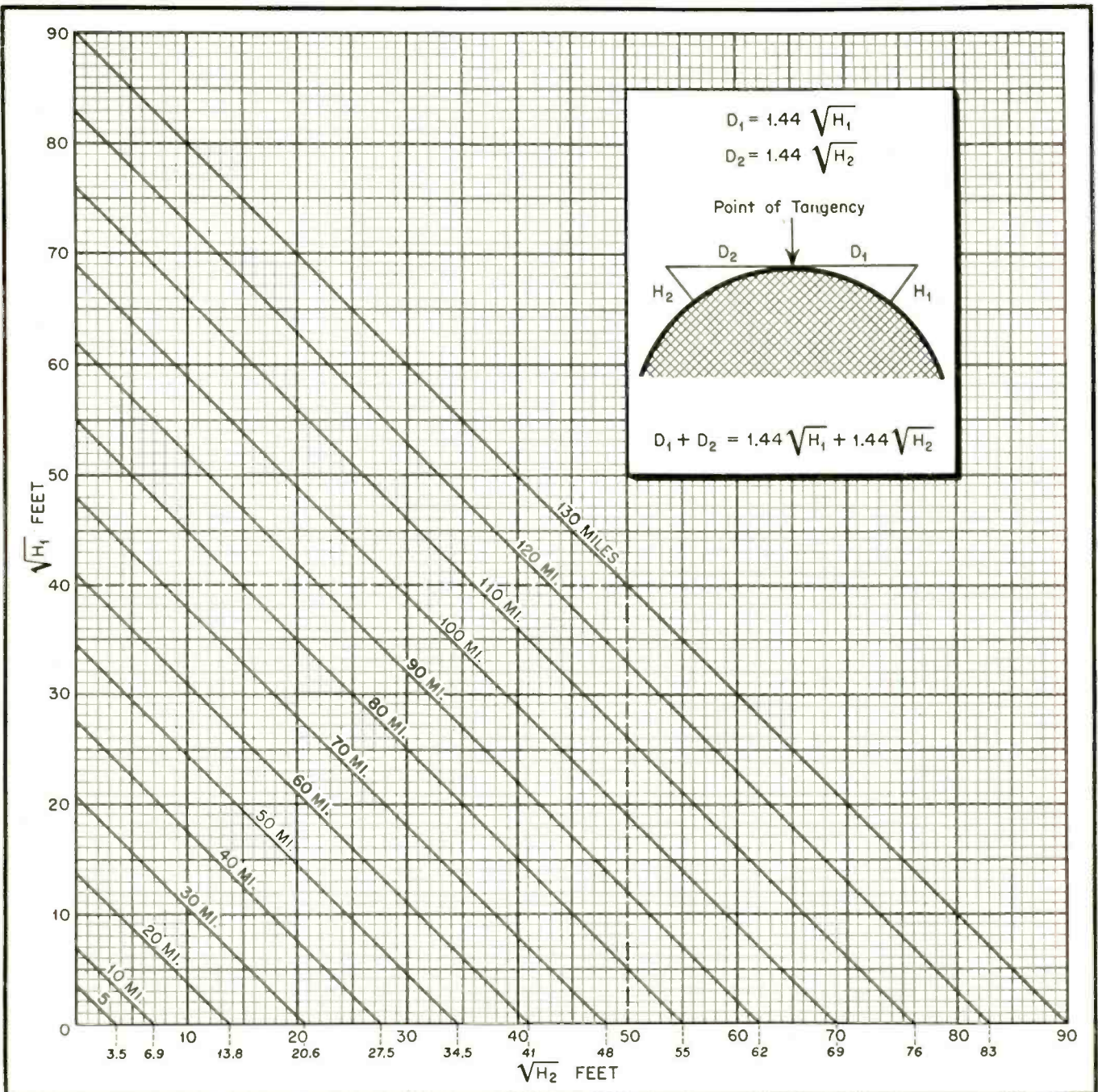

crease in the diameter of the earth which is generally used is 4/3. While this value is commonly assumed, it must be remembered that other values will sometimes give closer agreement with practical measurements. This multiplier is probably in most general usage today, however, for simplified computation.

In Radio Design Worksheet No. 10 it was shown in Problem 4\* that:

$$D_1 = \sqrt{2RH} \text{ approximately}$$

where:  $R$  = radius of earth.

If:  $R = 4000$  miles

Then:  $4/3 R = 5334$  miles

And:

$$D_1 = \frac{\sqrt{2} \sqrt{5334}}{\sqrt{5280}} \sqrt{H_1} = 1.44 \sqrt{H_1}$$

where:  $D_1$  and  $R$  are measured in miles and  $H_1$  in feet.

Whence:

$$D_1 + D_2 = 1.44 \sqrt{H_1} + 1.44 \sqrt{H_2} \quad (1)$$

Plotting  $\sqrt{H_1}$  against  $\sqrt{H_2}$  with  $D_1 + D_2$  as a parameter, a family of curves such as shown in the accompanying chart results. This is a convenient chart for the rapid determination of optical paths and is often used for this purpose. As an example of its use, assume a desired range of 130 miles; then if:

$H_1 = 0$  (i.e., surface of the earth)

$H_2 = 90 \times 90 = 8100$  feet.

Again, for the same range, if the elevation of the transmitting antenna is 2500 feet:

$$\sqrt{H_2} = \sqrt{2500} = 50$$

From the chart the corresponding receiver antenna elevation would be:

$$\sqrt{H_1} = 40$$

$$H_1 = 40 \times 40 = 1600 \text{ feet}$$

Further assume an airplane with antenna affixed to the fuselage to be flying at an altitude of 10,000 feet, and let the antenna elevation of the ground station be 16 feet. Then:

$$D_1 + D_2 = 1.44 \sqrt{H_1} + 1.44 \sqrt{H_2} =$$

$$1.44 \sqrt{16} + 1.44 \sqrt{10,000} =$$

$$(1.44 \times 4) + (1.44 \times 100) =$$

$$5.76 + 144 = 149.76$$

or about 150 miles.

### PHASE-MODULATED WAVE

**Problem:** Derive the expression for a phase-modulated wave showing carrier and side frequencies.

**Solution:** The general expression for an alternating current is:

\* This is a restatement of the theoretical problem appearing on page 24 of the February, 1943, issue of RADIO. The new chart accompanying the above text is of practical value as the usual correction factors have been taken into account in its preparation.

$$I = A \cos(\omega t + \theta) \quad (1)$$

Let this current be modulated by the signal:

$$KA \cos pt \quad (2)$$

In Radio Design Worksheet No. 11 (page 30, March 1943 RADIO) it was shown in Problem 3 that a modulated

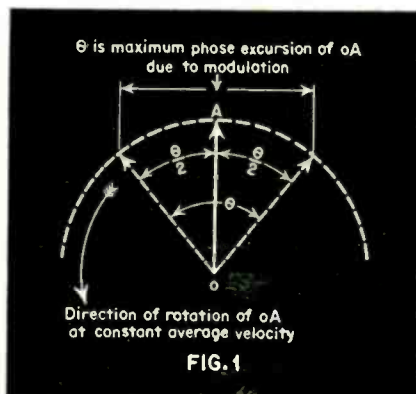

Physical picture of phase modulation.

wave involving a carrier as shown in (1) modulated by a signal as shown in (2) had the form:

$$I_1 = A \cos \omega t (1 + K \cos pt) \quad (3)$$

From (3) assuming  $\theta$  to be varied in accordance with the signal  $KA \cos pt$  we have:

$$I = A \cos [\omega t + \theta (1 + K \cos pt)] \quad (4)$$

By reasoning similar to that in Radio Design Worksheet No. 11, this reduces to:

$$I = A \cos(\omega t + \theta) \cos(K\theta \cos pt) - A \sin(\omega t + \theta) \sin(K\theta \cos pt) \quad (5)$$

Expanding the sine and cosine terms in accordance with their power series:

$$\begin{aligned} \sin \theta &= \theta - \frac{\theta^3}{6} + \frac{\theta^5}{120} - \frac{\theta^7}{2520} + \dots \\ \cos \theta &= 1 - \frac{\theta^2}{2} + \frac{\theta^4}{24} - \frac{\theta^6}{720} + \dots \end{aligned}$$

Equation (5) therefore becomes:

$$\begin{aligned} I = A \cos(\omega t + \theta) - AK\theta \sin(\omega t + \theta) \cos pt &+ \frac{AK^2\theta^2}{2} \cos(\omega t + \theta) \cos^2 pt \\ &- \frac{AK^2\theta^2}{6} \sin(\omega t + \theta) \cos^3 pt + \dots \quad (6) \end{aligned}$$

It will be recalled that:

$$\begin{aligned} \sin(x + y) &= \sin x \cos y + \cos x \sin y \\ \sin(x - y) &= \sin x \cos y - \cos x \sin y \end{aligned}$$

Adding these two expressions yields:

$$\sin x \cos y = \frac{1}{2} \sin(x + y) + \frac{1}{2} \sin(x - y) \quad (7)$$

It will also be recalled that:

$$\begin{aligned} \cos(x + y) &= \cos x \cos y - \sin x \sin y \\ \cos(x - y) &= \cos x \cos y + \sin x \sin y \end{aligned}$$

Adding these two expressions yields:

$$\cos x \cos y = \frac{1}{2} \cos(x + y) + \frac{1}{2} \cos(x - y) \quad (8)$$

From equation (6) the term:

$$\begin{aligned} AK\theta \sin(\omega t + \theta) \cos pt &= \frac{AK\theta}{2} \sin(\omega t + \theta + pt) \\ &+ \frac{AK\theta}{2} \sin(\omega t + \theta - pt) \end{aligned}$$

Since  $\cos^2 pt = \frac{1}{2} \cos 2pt + \frac{1}{2}$ , the third term to the right of the equality sign in equation (6) becomes:

$$\begin{aligned} \frac{AK^2\theta^2}{2} \cos(\omega t + \theta) \cos^2 pt &= \frac{AK^2\theta^2}{4} \cos(\omega t + \theta) \\ &+ \frac{AK^2\theta^2}{4} \cos(\omega t + \theta) \cos 2pt \\ &= \frac{AK^2\theta^2}{4} \cos(\omega t + \theta) + \frac{AK^2\theta^2}{4} [\frac{1}{2} \cos(\omega t + \theta + 2pt) \\ &+ \frac{1}{2} \cos(\omega t + \theta - 2pt)] \\ &= \frac{AK^2\theta^2}{4} \cos(\omega t + \theta) + \frac{AK^2\theta^2}{8} \cos(\omega t + \theta + 2pt) \\ &+ \frac{AK^2\theta^2}{8} \cos(\omega t + \theta - 2pt) \end{aligned}$$

Whence equation (6) becomes:

$$\begin{aligned} I = A \cos(\omega t + \theta) - \frac{AK\theta}{2} \sin(\omega t + \theta + pt) &+ \frac{AK\theta}{2} \sin(\omega t + \theta - pt) \\ &- \frac{AK^2\theta^2}{4} \cos(\omega t + \theta) \\ &+ \frac{AK^2\theta^2}{8} \cos(\omega t + \theta + 2pt) - \frac{AK^2\theta^2}{8} \cos(\omega t + \theta - 2pt) + \dots \quad (9) \end{aligned}$$

Collecting terms, we have:

$$\begin{aligned} I = \frac{4A - AK^2\theta^2}{4} \cos(\omega t + \theta) - \frac{AK\theta}{2} \sin(\omega t + \theta + pt) &+ \frac{AK\theta}{2} \sin(\omega t + \theta - pt) \\ &- \frac{AK^2\theta^2}{8} \cos(\omega t + \theta + 2pt) \\ &+ \frac{AK^2\theta^2}{8} \cos(\omega t + \theta - 2pt) + \dots \quad (10) \end{aligned}$$

which is the equation desired.

The phase-modulated wave therefore contains a carrier:

$$\frac{4A - AK^2\theta^2}{4} \cos(\omega t + \theta)$$

[Continued on page 55]



# Q. & A. STUDY GUIDE

## C. RADIUS

### A-F AMPLIFICATION—IV

#### Push-Pull Amplifiers

27. How may even harmonic energy be reduced in the output of an audio-frequency amplifier? (V-159)

28. Why is a push-pull audio-frequency amplifier preferable to a single-tube stage? (V-155)

29. What are the advantages of push-pull amplification as compared to single-ended amplification? (V-54)

30. What are the advantages of using two tubes in push-pull as compared with the use of the same tubes in parallel in an audio-frequency amplifier? (III-158)

Fig. 1 illustrates how two power tubes can be connected in parallel and deliver twice the power output with the same signal. The greater power

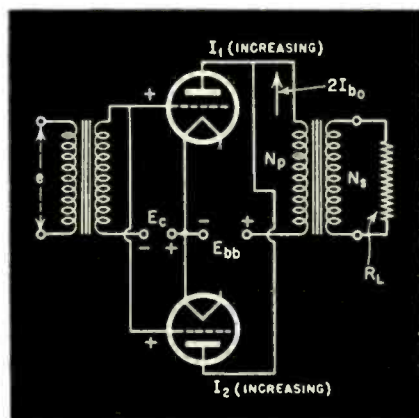

Fig. 1. Circuit showing parallel operation of triode tubes.

sensitivity and the reduction of the generator impedance which provides greater effective damping of a resonant load are the major advantages gained by this circuit arrangement. The efficiency in both tube and associated circuit elements with respect to power dissipation has not been increased. There is an increased tendency toward direct-current magnetization of the output transformer which may impair the low-frequency response. No effective reduction in distortion is obtained.

Fig. 2 illustrates how the same tubes can be connected so that all of the desirable features mentioned above are attained. This circuit is known as a push-pull or balanced amplifier. A sig-

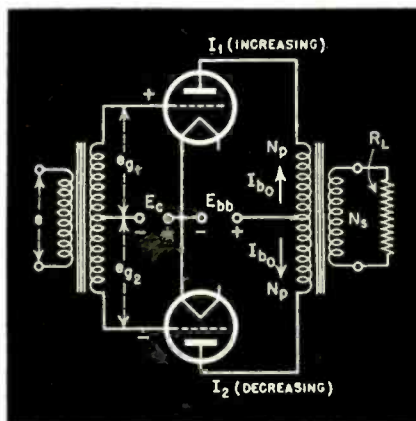

Fig. 2. Circuit showing push-pull operation of triode tubes.

nal  $e$  impressed across the primary of the input transformer induces equal and opposite voltages,  $e_{g1}$  and  $e_{g2}$ , in the two halves of the secondary. The plate currents are therefore 180 degrees out of phase. Because of coupling between the plate circuits of the two tubes through the mutual induc-

tance between the two halves of the primary winding, the changing plate current in one tube affects the change in plate current in the other tube. As a result of this the load line for the individual tube is no longer a straight line when  $R_L$  is resistive. This increases the generation of even-order harmonics as far as the individual tube is concerned. However, because of the phase relation between the currents in the two tubes, these unsymmetrical plate current waves add together to produce a symmetrical wave which constitutes the load current. See Fig. 3. Hence, in push-pull the even-order harmonics, which cause the unsymmetrical plate current wave, are eliminated.

Since there is marked reduction in distortion in the push-pull amplifier, it is possible to make the load impedance more nearly equal to the generator impedance. Each tube delivers more power than in single-ended operation. The push-pull Class A amplifier, therefore, delivers somewhat more than twice the power produced by the same tube un-

[Continued on page 61]

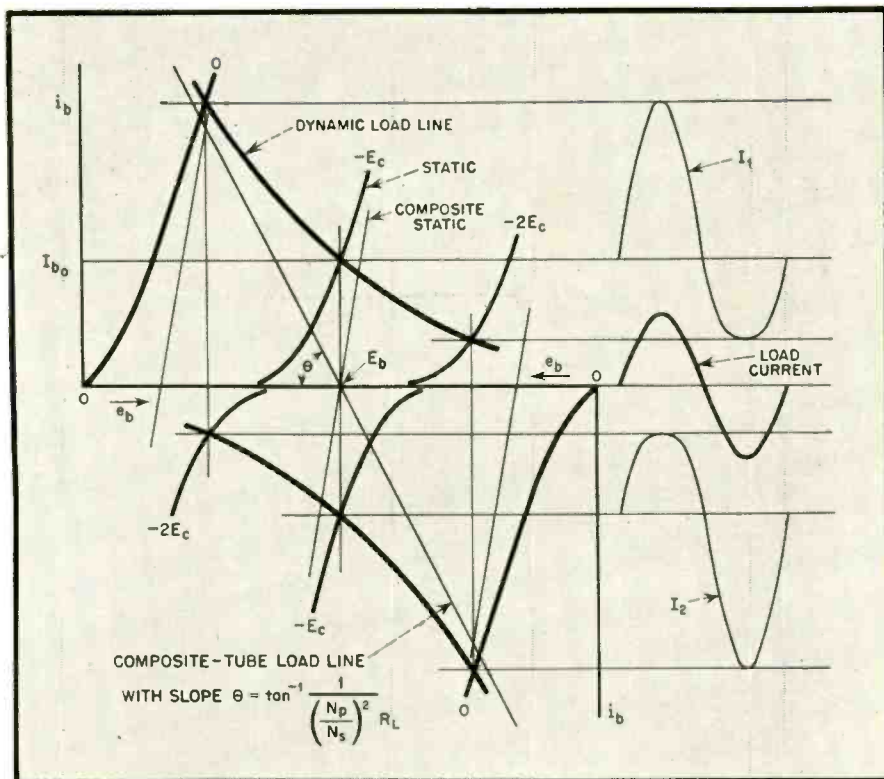

Fig. 3. Push-pull operation with triodes.

[Continued from page 20]

"The simple truth is that neither below *b* nor at *d* does negative feedback obtain. This is explained by the vector diagrams of Fig. 3; they are based on the fact that the coupling transformer is in effect a complicated network of mutual inductance, leakage reactance *L*, shunting capacities on primary and secondary (*C*), etc. This is . . . roughly indicated here in Fig. 4. Hence, while the secondary voltage *V<sub>s</sub>* is always very nearly 90 degrees out of phase with the primary current *I<sub>a</sub>*, the phase angle between the anode circuit emf— $-\mu V_g$  and *I<sub>a</sub>* varies from a slight to a large lagging angle as the frequency increases from *a* to and beyond *b*, since the effective load in this region is mainly the primary inductive reactance which increases with frequency. But at some point between *b* and *d* the transformer becomes effectively bypassed by the series combination consisting of *L* and *C*. The angle  $\phi$  thus increases again, becoming zero at *d* where *L* resonates with *C*. Hence the output voltage is in quadrature with *V<sub>g</sub>* at this frequency and feeding back a fraction of the former in the way shown would not provide negative feedback. Hence the hump at *d* is, if anything, increased relatively. Beyond

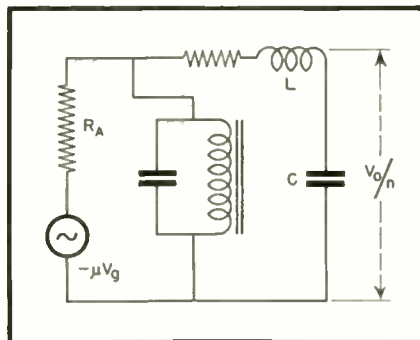

Fig. 4. Equivalent circuit of Fig. 1, showing the electrical characteristics.

*d* the load is likely to be capacitive on account of the primary shunt capacity and a small amount of negative feedback may obtain once more.

"Again, at the low-frequency end below *b* the anode load is small but inductive, hence *I<sub>a</sub>* is nearly in phase with  $-\mu V_g$  and *V<sub>s</sub>* very nearly in quadrature with it; so feedback would not be negative with the connections shown. As shown by the fall of the characteristic, it does become so above *b*. Incidentally, this is a resonance like effect although no capacity is present; it might be put to good use in special work where a low-frequency "resonance" is desired without a bulky condenser.

"The basic cure for the resonant rise in the frequency characteristic is not to use feedback, but to eliminate it by some known stratagem, such as a resistance shunt on the secondary. This would also modify the phase-frequency characteristic suitably and allow of negative feedback above *b*.

"Thus it seems axiomatic that feedback can correct frequency distortion in voltage amplifiers if, and only if, the distortion is not due to series resonance."

★

## MULTI-RANGE METERS

A SUBSTANTIAL REDUCTION in the number of shunt and multiplier resistances in multi range volt-milliammeters can be obtained when the "multi-stage" principle is applied to the shunt and multiplier circuits. This principle is explained in an article appearing in the *Journal of Scientific Instruments* (England) for January 1943 by G. E. Roth entitled: A Multi-range Direct-Current and Voltmeter Circuit.

In most circuits employed for multi-range instruments one resistor is needed for each range. This number of

units can be reduced by the "multi-stage" principle which consists in adding a universal shunt to a meter and then shunting it again, thereby obtaining a new set of ranges. The system is best explained by quoting a part of the article.

"The multiplying factor of a 'multi-stage' circuit for any given setting is the product of the multiplying factors *F*, *F'*, *F''*, *F'''*, . . . of those of its single stages which are included in the circuit for this setting. The values of these single-stage factors *F*, *F'*, *F''*, . . . in terms of the internal resistance of the measuring instrument can be derived as follows:

"Fig. 5 shows a conventional universal-shunt circuit for an instrument *M* having an internal resistance of *R* ohms. Without any shunt a current of *I* amperes will cause a full-scale deflection of *M*. In the circuit of Fig. 5 the current required to cause full-scale deflection of *M* is *F* × *I*, where the multiplying factor *F* is given by the well-known formula

[Continued on page 64]

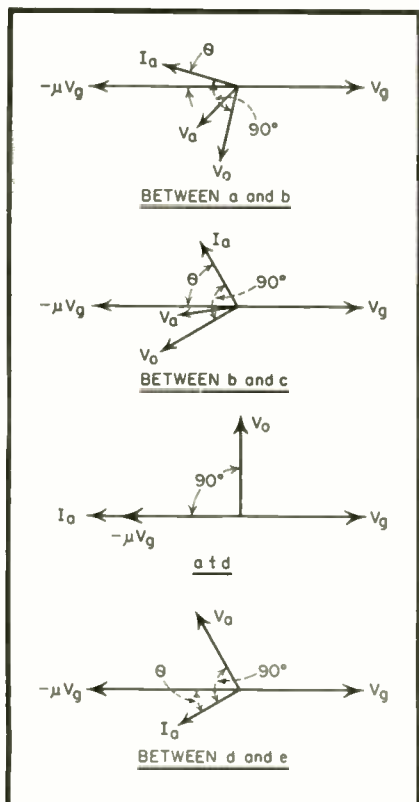

Fig. 3. Vectors relating to Fig. 1.

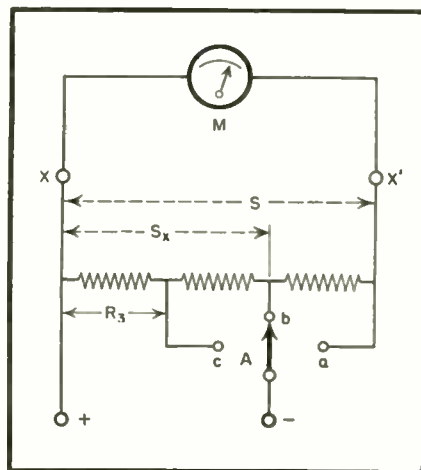

Fig. 5. Schematic diagram of conventional universal-shunt arrangement.

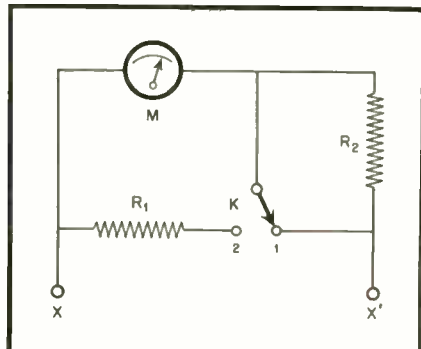

Fig. 6. Alternate switch circuit.



# RADIO BIBLIOGRAPHY

F. X. RETTENMEYER

RCA Victor Division  
Radio Corporation of America

## 12—TELEVISION: SECTION 1, PART 1

Continuous Wave Interference with Television Reception—C. N. Smyth—*Electrical Communication*, Vol. 19, No. 4, 1941, page 110.

Antennas and Transmission Lines at the Empire State Television Station—N. E. Lindenblad—*Communications*, Vol. 21, No. 4, April 1941, page 10.

Audio and Video on a Single Carrier—H. E. Kallmann—*Electronics*, Vol. XIV, May 1941, page 39.

F. C. C. Hearing on Commercial Television, *Electronics*, Vol. XIV, April 1941, page 18.

National Television System Committee Proposes Television Standards, *Electronics*, Vol. XIV, February 1941, page 18.

Photographic Analysis of Television Images—D. G. Fink—*Electronics*, Vol. XIV, August 1941, page 24.

Simple Television Preamplifier—Muniz & Tait—*Electronics*, Vol. XIV, April 1941, page 39.

Storage in Television Reception—A. H. Rostenthal—*Electronics*, Vol. XIV, October 1941, page 46.

Television Reference Data, *Electronics*, Vol. XIV, June 1941, page 49.

Television Reception in an Airplane—R. S. Holmes—*RCA Review*, Vol. IV, January 1940, page 286.

RCA Television Field Pickup Equipment—T. A. Smith—*RCA Review*, Vol. IV, January 1940, page 290.

Simplified Television I-F Systems—G. Mountjob—*RCA Review*, Vol. IV, January 1940, page 299.

The Gradation of Television Pictures—H. E. Kallmann—*Proceedings IRE*, Vol. 28, No. 4, April 1940, page 170.

A System of Large-Screen Television Reception Based on Certain Electron Phenomena in Crystals—A. H. Rostenthal—*Proceedings IRE*, Vol. 28, No. 5, May 1940, page 243.

Quality in Television Pictures—P. C. Goldmark and I. N. Dyer—*Proceedings IRE*, Vol. 28, No. 8, August 1940, page 343.

Portable Equipment for Observing Transient Response of Television Apparatus—H. E. Kallmann—*Proceedings IRE*, Vol. 28, No. 8, August 1940, page 351.

Some Factors Affecting the Choice of Lenses for Television Cameras—H. B. De Vore and H. Lams—*Proceedings IRE*, Vol. 28, No. 8, August 1940, page 369.

The Generation for Television of Horizontal Synchronous Pulses from Vertical Pulses by Means of Impulse Excitation—J. B. Sherman—*Proceedings IRE*, Vol. 28, No. 9, September 1940, page 406.

The RCA Portable Television Pickup Equipment—G. L. Beers, O. H. Schade

and R. E. Shelly—*Proceedings IRE*, Vol. 28, No. 10, October 1940, page 450.

The Subjective Sharpness of Simulated Television Images—M. W. Balden—*Proceedings IRE*, Vol. 28, No. 10, October 1940, page 458.

A Deflection and Video Chassis for Television Reception—Larence—*QST*, Vol. XXIV, February 1940, page 29.

A Design for Living—With Television—Rosenblatt—*QST*, Vol. XXIV, March 1940, page 44.

An Efficient U.H.F. Unit for the Amateur Television Transmitter—Waller—*QST*, Vol. XXIV, July 1940, page 32.

New Amateur Television Records, *QST*, Vol. XXIV, December 1940, page 53.

A New Electronic Television Transmitting System for the Amateur—Sherman—*QST*, Vol. XXIV, May 1940, page 30.

A New Iconoscope for Amateur Television Cameras—Lamb—*QST*, Vol. XXIV, June 1940, page 13.

A Receiver for the New Amateur Television System—Sherman—*QST*, Vol. XXIV, June 1940, page 38.

Simplifying Television Deflection and Video Chassis, *QST*, Vol. XXIV, October 1940, page 74.

Television Camera-Modulator Design for Practical Amateur Operation—Lamb—*QST*, Vol. XXIV, October 1940, page 11.

Two-Way Television Communication Inaugurated, *QST*, Vol. XXIV, November 1940, page 36.

British Vision Receivers—W. J. Brown—*Electronics*, Vol. XIII, March 1940, page 26.

Business Side of Television—N. E. Kersta—*Electronics*, Vol. XIII, March 1940, page 10.

Color Television Demonstrated by CBS Engineers, *Electronics*, Vol. XIII, October 1940, page 32.

Du Mont Proposals, *Electronics*, Vol. XIII, February 1940, page 22.

Federal Communications Commission and Television, *Electronics*, Vol. XIII, May 1940, page 11.

Frequency Modulation Applied to a Television System—C. W. Carnahan—*Electronics*, Vol. XIII, February 1940, page 26.

Interspersed Frequency Modulation and Amplitude Modulation in a Television Signal—A. V. Loughran—*Electronics*, Vol. XIII, February 1940, page 27.

National Television Systems Committee Organizes, *Electronics*, Vol. XIII, August 1940, page 34.

Pre-selector Circuit for Television Receivers—B. F. Tyson—*Electronics*, Vol. XIII, November 1940, page 23.

Receivers for Television Using Electrostatic Deflection—T. T. Goldsmith, Jr.—

*Electronics*, Vol. XIII, June 1940, page 16.  
Shunt-Peaking Compensation—W. H. Freeman—*Electronics*, Vol. XIII, May 1940, page 34.

Television Changeover, *Electronics*, Vol. XIII, October 1940, page 24.

Television Technique Adopted in Photographing Sun's Corona, *Electronics*, Vol. XIII, February 1940, page 34.

Television Receiving Antennas and Transmission Lines—A. W. Barber—*Communications*, Vol. 20, No. 2, February 1940, page 15.

Continuous Wave Interference with Television Reception—A. N. Smyth—*Communications*, Vol. 20, No. 9, September 1940, page 5.

An Iconoscope Pre-amplifier—A. A. Barco—*RCA Review*, Vol. IV, July 1939, page 89.

Selective Side-Band Transmission in Television—R. D. Kell and G. L. Fredendall—*RCA Review*, Vol. IV, July 1939, page 83.

Television Economics—A. N. Goldsmith—*Communications*, Vol. 19, No. 2, February 1939, page 18.

Television Receiver Design Factor—W. M. Perkins—*Communications*, Vol. 19, No. 2, February 1939, page 32.

The Du Mont Television System—T. T. Goldsmith, Jr.—*Communications*, Vol. 19, No. 2, February 1939, page 38.

Practical Aspects of Wide-Band Television Amplifier Design—F. A. Everest—*Communications*, Vol. 19, No. 3, March 1939, page 21.

Safety in Television Receivers—A. W. Barber—*Communications*, Vol. 19, No. 3, March 1939, page 26.

Radio Transmission Considerations: Sound vs. Picture—T. A. Smith—*Communications*, Vol. 19, No. 3, March 1939, page 30.

Kinescopes for Television Receivers—L. C. Waller—*Communications*, Vol. 19, No. 4, April 1939, page 20.

Fluorescent Materials for Television Tubes—G. T. Schmidling—*Communications*, Vol. 19, No. 4, April 1939, page 30.

Miniature Staging—W. E. Eddy—*Communications*, Vol. 19, No. 4, April 1939, page 22.

Sound Motion Picture Films in Television—J. A. Mauer—*Communications*, Vol. 19, No. 5, May 1939, page 28.

Television Lighting—W. C. Eddy—*Communications*, Vol. 19, No. 5, May 1939, page 17.

A Television Pickup Tube—H. A. Finke—*Proceedings IRE*, Vol. 27, No. 2, February 1939, page 144.

Transient Response of Multistage Video-Frequency Amplifiers—A. V. Bedford and

[Continued on page 44]

- G. L. Fredendall—*Proceedings IRE*, Vol. 27, No. 4, April 1939, page 277.
- Wide-Band Amplifiers for Television—H. A. Wheeler—*Proceedings IRE*, Vol. 27, No. 7, July 1939, page 420.
- The Supersonic Light Control and Its Application to Television with Special Reference to the Scophony Television Receivers—D. M. Robinson—*Proceedings IRE*, Vol. 27, No. 8, August 1939, page 483.
- The Design and Development of Television Receivers Using the Scophony Optical Scanning System—J. Sieger—*Proceedings IRE*, Vol. 27, No. 8, August 1939, page 487.
- Synchronization of Scophony Television Receivers—G. Wikkenhauser—*Proceedings IRE*, Vol. 27, No. 8, August 1939, page 492.
- Some Factors Involved in the Optical Design of a Modern Television Receiver Using Moving Scanners—H. W. Lee—*Proceedings IRE*, Vol. 27, No. 8, August 1939, page 506.
- A High-Efficiency Modulating System—A. W. Vance—*Proceedings IRE*, Vol. 27, No. 8, August 1939, page 506.
- Contrast in Kinescopes—R. R. Law—*Proceedings IRE*, Vol. 27, No. 8, August 1939, page 511.
- Recent Improvements in the Design and Characteristics of the Iconoscope—R. B. Janes and W. H. Hickok—*Proceedings IRE*, Vol. 27, No. 9, September 1939, page 535.
- The Image Iconoscope—H. Iams, G. A. Morton and V. K. Zworykin—*Proceedings IRE*, Vol. 27, No. 9, September 1939, page 541.
- Television Pick-up Tubes Using Low Velocity Electron Beam Scanning—A. Rose and H. Iams—*Proceedings IRE*, Vol. 27, No. 9, September 1939, page 547.
- The Electrostatic Electron Multiplier—V. K. Zworykin and J. A. Rajchman—*Proceedings IRE*, Vol. 27, No. 9, September 1939, page 558.
- A Theoretical Analysis of Single-Sideband Operation of Television Transmitters—L. S. Nergaard—*Proceedings IRE*, Vol. 27, No. 10, October 1939, page 666.
- Stroboscopic Light Source—H. E. Kallmann—*Proceedings IRE*, Vol. 27, No. 11, November 1939, page 690.
- Television Detail and Selective-Sideband Transmission—S. Goldman—*Proceedings IRE*, Vol. 27, No. 11, November 1939, page 725.
- The Physical Aberration of Magnetic Focusing Coils—H. Marshall—*Telefunken & Rohre*, No. 16, 1939, page 190.
- Radial Scanning, *Wireless World*, June 15, 1939, page 555.
- Noise in Television Receivers—S. West—*Wireless World*, June 15, 1939, page 563.
- Line Deflectors—D. V. Ridgeway—*Wireless World*, June 15, 1939, page 550.
- Orthicon, *Electronics*, Vol. 12, July 1939, page 11.
- Survey of Television Pickup Devices—K. McIlwain—*Jour. App. Phys.*, Vol. 10, July 1939, page 432.
- E. M. I. Cathode-Ray Television Transmission—J. D. McGee and H. G. Lubszynski—*Journal IEE* (London), Vol. 84, April 1939, page 468.
- Cathode-Ray Television Tubes—M. Knoll—*Telefunken Hausmitteilungen*, 20th year, July 1939, page 65.
- Capacity-Modulated Cathode-Ray Scanning Tubes—M. Knoll and R. Thiegle—*Teleg. Fern. und Funk-Techn.*, Vol. 27, November 1938, page 538.
- The Wireless Exhibition—1939—A Technical Survey, *Wireless Engineer*, Vol. 16, October 1939, page 510.
- Philco Demonstrates Improved Picture Tube, *Radio & Tel. Weekly*, Vol. 27, June 21, 1939, page 6.
- On the Present Position of the Problem of Post-Deflection Acceleration in Cathode-Ray Tubes—E. Schwartz—*Fernsch. A.G.*, Vol. 1, December 1938, page 19.
- Post-Acceleration in Cathode-Ray Tubes—Rogowski and Thielen—*Arch. fur. Elektrotech.*, Vol. 33, June 14, 1939, page 411.
- The Further Development of Our Receiver and Picture Viewing Devices for 1939—R. Moller and G. Schubert—*Fernsch. A.G.*, Vol. 1, August 1939, page 153.
- The Deflection of the Electron Ray in the Cathode-Ray Tube by Magnetic Fields Produced by Coils—H. Bahring—*Fernsch. A.G.*, Vol. 1, December 1938, page 15.
- Baird Cinema Equipment, *Television*, Lond., Vol. 12, April 1939, page 199.
- Methods and Arrangements for the Application of the Storage Principle in Television Reception—M. von Ardenne—*Teleg. Fern. und Funk-Techn.*, Vol. 27, November 1938, page 518.
- Storage Methods in Television Reception—M. von Ardenne—*Television*, Lond., Vol. 12, February 1939, page 67.
- Calculation by Successive Approximations of the Electrostatic Field of a Cylindrical System—A. Boni—*Radio e Televisione*, Vol. 3, May 1939, page 675.
- The Focusing of Electrons Possessing High Velocities and the General Properties of Centered Systems in Relativistic Mechanics—Cutte—*Rev. Gen. d'Elec.*, Vol. 45, May 20, 1939, page 675.
- On an Electrostatic High-Voltage Lens of Short Focal Length—M. von Ardenne—*Naturwiss.*, Vol. 27, September 8, 1939, page 114.
- The Aperture Error of Electrostatic Tube Lenses—Gundert—*Zeit. fur. Phys.*, Vol. 112, June 1, 1939, page 689.
- The Effect of Chromatic Error on Electron Microscope Images—Hillier—*Canadian Journal Res.*, Vol. 17, April 1939, page 64.
- Remarks on the Magnitude of the Chromatic Error in the Electron Microscope—M. von Ardenne—*Zeit. fur. Phys.*, Vol. 113, July 4, 1939, page 257.
- Experiments, Calculations and Results of the Problem of the Resolving Power of the Super Microscope—Von Borries and Ruska—*Zeit. fur. Phys.*, Vol. 20, Nov. 8, 1939, page 225.
- Question of Intensity and Resolving Power of the Electron Microscope—M. von Ardenne—*Zeit. fur. Phys.*, Vol. 112, June 1, 1939, page 744.
- The Shadow Microscope; a New Electron Super-Microscope — Boersch—*Naturwiss.*, Vol. 27, June 9, 1939, page 418.
- Efficiency of the Electron Shadow Microscope—M. von Ardenne—*Naturwiss.*, Vol. 27, July 14, 1939, page 485.
- Amplifier Band-Width Similitude Principles—S. Ramo—*Communications*, Vol. 19, No. 5, May 1939, page 16.
- Insulation in Television—W. Naumberg—*Communications*, Vol. 19, No. 6, June 1939, page 24.
- The Fine Structure of Television Images—H. A. Wheeler and A. V. Loughren—*Proceedings IRE*, Vol. 26, No. 5, May 1938, page 540.
- A Unique Method of Modulation for High-Fidelity Television Transmitters—W. N. Parker—*Proceedings IRE*, Vol. 26, No. 8, August 1938, page 946.
- The Problem of Synchronization in Cathode-Ray Television—F. J. Bingley—*Proceedings IRE*, Vol. 26, No. 11, November 1938, page 1327.
- Some Notes on Video Amplifier Design—A. Preisman—*RCA Review*, Vol. 11, April 1938, page 421.
- Direct-Viewing Type Cathode-Ray Tube for Large Television Images—I. G. Malloff—*RCA Review*, Vol. 11, January 1938, page 289.
- The Monoscope—C. E. Burnett—*RCA Review*, Vol. 11, April 1938, page 414.
- Coaxial Cable System for Television Transmission—M. E. Strieby—*Bell System Tech. Journal*, Vol. XVII, July 1938, page 438.
- Television Cathode-Ray Tubes for the Amateur—R. S. Burnap—*RCA Review*, Vol. 11, January 1938, page 297.
- The Electron Master Microscope: Theoretical Foundations—M. von Ardenne—*Zeit. fur. Phys.*, Vol. 109, July 11, 1938, page 553.
- Introduction to Modern Cathode Ray Television Reception—M. P. Wilder—*QST*, Vol. XXI, No. 12, December 1937, page 11.
- Television Simplified, *Electronics*, March 1938, page 33.
- The Construction of Television Receivers—M. P. Wilder—*QST*, Vol. XXII, No. 5, May 1938, page 39.
- Television I.F. Amplifiers—W. T. Cocking—*Wireless Engineer*, Vol. XV, No. 178, July 1938, page 358.
- The Scophony Television Receiver—H. W. Lee—*Nature*, July 9, 1938, page 59.
- Television in Great Britain—N. Ashbridge—*Proceedings IRE*, Vol. 25, No. 6, June 1937, page 697.
- Development of the Projection Kinescope—V. K. Zworykin and W. H. Palmer—*Proceedings IRE*, Vol. 25, No. 8, August 1937, page 937.
- High Current Electron Gun for Projection Kinescopes—R. R. Law—*Proceedings IRE*, Vol. 25, No. 8, August 1937, page 954.
- Theoretical Limitations of Cathode-Ray Tubes — D. B. Langmuir — *Proceedings IRE*, Vol. 25, No. 8, August 1937, page 977.
- A Circuit for Studying Kinescope Resolution—C. E. Burnett—*Proceedings IRE*, Vol. 25, No. 8, August 1937, page 992.
- An Oscillograph for Television Development—A. C. Stocker—*Proceedings IRE*, Vol. 25, No. 8, August 1937, page 1012.
- The Brightness of Outdoor Scenes and Its Relation to Television Transmission—H. Iams, R. B. Janes and W. H. Hickok—*Proceedings IRE*, Vol. 25, No. 8, August 1937, page 1034.
- Theory and Performance of the Iconoscope—V. K. Zworykin, G. A. Morton and

[Continued on page 46]



**"JUST THINK, HOGARTH, IT TOOK  
ECHOPHONE EC-1 AND TOTAL  
WAR TO BRING US TOGETHER!"**

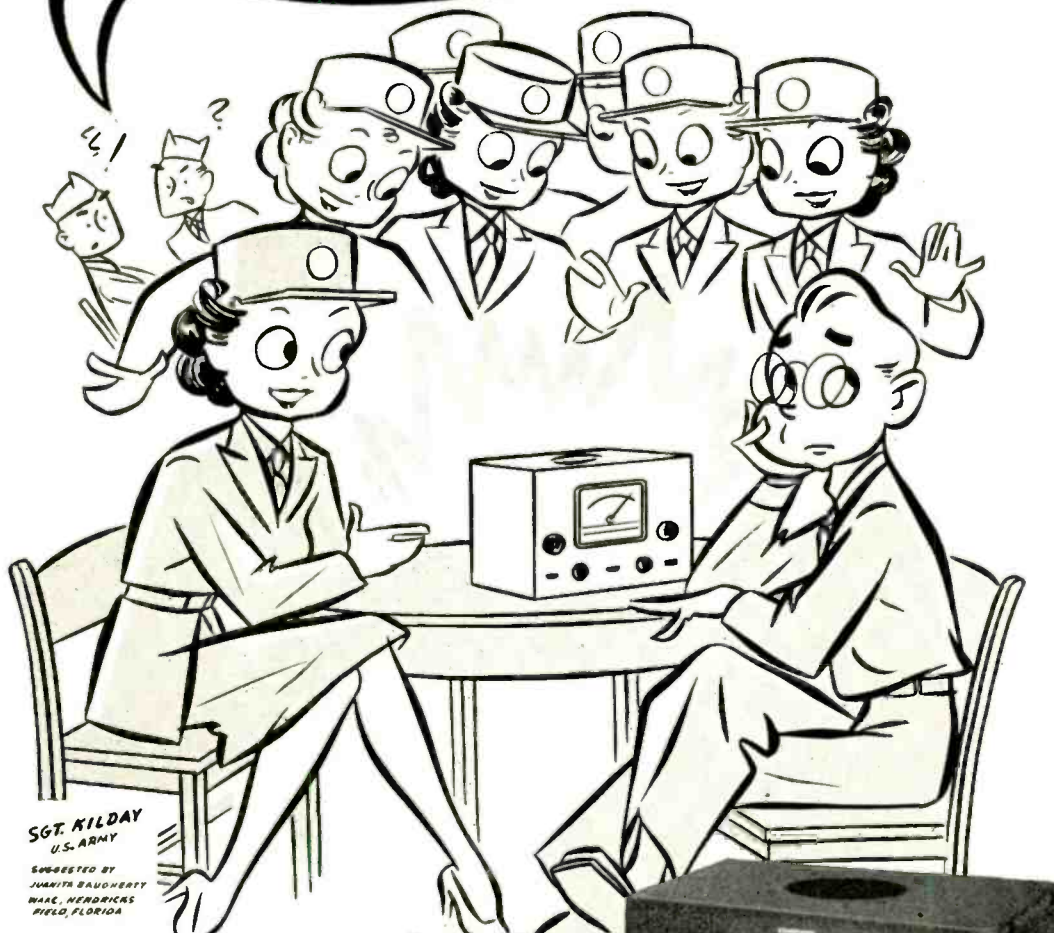

**SGT. KILDAY**  
U.S. ARMY

SUGGESTED BY  
JUANITA BAUGHERTY  
WALK, NEBRASKA  
FIELD, FLORIDA

### ***Echophone Model EC-1***

(Illustrated) a compact communications receiver with every necessary feature for good reception. Covers from 550 kc. to 30 mc. on three bands. Electrical bandspread on all bands. Six tubes. Self-contained speaker. Operates on 115-125 volts AC or DC.



**ECHOPHONE RADIO CO., 201 EAST 26th ST., CHICAGO, ILLINOIS**

- A. Rose—*Proceedings IRE*, Vol. 25, No. 8, August 1937, page 1071.
- Television Pickup Tubes with Cathode-Ray Beam Scanning—H. Iams and A. Rose—*Proceedings IRE*, Vol. 25, No. 8, August 1937, page 1048.
- Analysis and Design of Video Amplifiers—S. W. Seeley and C. N. Kimball—*RCA Review*, Vol. 11, October 1937, page 171.
- A Novel Relay Broadcast Mobile-Unit Design—M. W. Rife—*RCA Review*, Vol. 11, October 1937, page 141.
- Equipment Used in the Current RCA Television Field Tests—R. R. Beal—*RCA Review*, Vol. 1, January 1937, page 36.
- Frequency Assignments for Television—C. W. Engstrom and C. M. Burrill—*RCA Review*, Vol. 1, January 1937, page 88.
- Partial Suppression of One Side Band in Television Reception—W. J. Poch and D. W. Epstein—*RCA Review*, Vol. 1, January 1937, page 19.
- Philco's 441 Line Television, *Electronics*, March 1937, page 8.
- Television European Style, *Electronics*, March 1937, page 32.
- Scanning in Television Receivers—F. J. Sommers—*Electronics*, October 1937, page 18.
- Television in Great Britain—H. M. Lewis and A. V. Loughren—*Electronics*, October 1937, page 32.
- Television Studio Stations—W. C. Eddy—*Comm. & Broadcast Eng.*, Vol. 4, No. 4, April 1937, page 12.
- Iconoscopes and Kinescopes in Television—V. K. Zworykin—*RCA Review*, Vol. 1, July 1936, page 60.
- RCA Television Field Tests—L. M. Clement and E. W. Engstrom—*RCA Review*, Vol. 1, July 1936, page 32.
- Television Radio Relay—B. Revor and O. E. Dow—*RCA Review*, Vol. 1, October 1936, page 35.
- Phase Distortion in Television—R. T. Shiffenbaum—*Wireless Engineer*, Vol. XIII, No. 148, January 1936, page 21.
- Interference from Television—F. R. W. Strafford—*Wireless World*, December 1936, page 630.
- British Plans for Home Television—B. H. Porter—*Comm. & Broadcast Eng.*, Vol. 3, No. 1, January 1936, page 16.
- The Eiffel Tower Television Installation—A. W. Cruse—*Comm. & Broadcast Eng.*, Vol. 3, No. 3, March 1936, page 18.
- Text of British Television Report, *Electronics*, March 1935, page 76.
- Gas Discharge Tubes and Their Application to Television—M. H. Harris—*Journal of the Television Society*, Ser. 11, Vol. 1, Part VII, March 1935, page 217.
- Optical Effects and Detail in Television Systems, *Marconi Review*, No. 48, May-June 1934, page 9.
- Television—V. K. Zworykin—*Journal of Franklin Institute*, Vol. 217, No. 1, January 1934, page 1.
- Television at the 32 Berlin Radio Exp.—E. H. Traub—*Journal of Television Society*, September 1932, page 155.
- The Eye: A Link in the Television Chain—W. D. Wright—*Journal of Television Society*, September 1932, page 150.
- Television in America Today—A. Densdale—*Journal of Television Society*, September 1932, page 137.
- Lens Design for Scanning Disc—Batchen—*Radio News*, May 1932, page 914.
- An Early Television and Picture Transmission Proposal, *Electrical Communications*, Vol. 10, July 1931, page 34.
- Character of Television Signals—C. H. W. Nason—*Radio Broadcast*, April 1930.
- Baird Television Scores—J. E. Anderson—*Radio World*, Vol. 16, January 11, 1930, page 7.
- Die Braunsche Rohre als Fernsehempfänger—M. von Ardenne—*Fernsehen*, Vol. 1, May 1930, page 193. (The Braun tube as a television receiver.)
- The Electrical Bloodhound; or The Police Business Improved—J. P. Arnold—*Projection Eng.*, Vol. 2, January 1930, page 11.
- Baird Television Receiver Tested, *Wireless World*, Vol. 26, March 1930, page 277.
- The Cathode-Ray Television Receiver, *Radio-Craft*, Vol. 1, February 1930, page 384.
- Cathode-Ray Television Receiver Developed, *Sci. Amer.*, Vol. 142, February 1930, page 147.
- About Scanning Discs—C. G. Cato—*Television*, Lond., Vol. 3, April 1930, page 94.
- Eyes Across the Sea—W. W. Chaplin—*Sci. and Inv.*, Vol. 18, May 1930, page 17.
- Television and Your Wireless Receiver—H. F. B. Chapple—*Television*, N. Y., Vol. 2, January 1930, page 536.
- A Novel Scanning Disc for Television—P. L. Clark—*Radio-Craft*, Vol. 1, January 1930, page 314.
- The Crystal Receiver for Television is Here!, *Wireless World*, Vol. 26, May 7, 1930, page 493.
- Le Normalisation des Appareils de Television Commerciale—B. Decaux—*Rev. Scientifique*, Vol. 68, March 8, 1930, page 152. (The standardization of commercial television apparatus.)
- The Fading and Distortion of Distant Signals—A. Dinsdale—*Wireless World*, Vol. 26, May 14, 1930, page 504.
- Le Cellule Photoelectrique et ses Applications Industrielles; Film Sonore et Television—L. Dunoyer—*Science et la Vie*, Vol. 37, June 1930, page 443. (The photoelectric cell and its industrial applications; the sound film and television.)
- Solving Television's Problems—C. J. Fitch—*Radio-Craft*, Vol. 1, June 1930, page 636.
- Television; Present and Future—Sir A. Fleming—*Television*, N. Y., Vol. 2, February 1930, page 581.
- Television Today—D. Fox—*Exhibitors Herald-World*, Vol. 99, April 12, 1930, page 27.
- Receiving a Television Image—W. C. Fox—*Television*, Lond., Vol. 3, April 1930, page 92.
- Television, Competitor or Partner?—H. B. Franklin—*Exhibitors Herald-World*, Vol. 98, Sec. 2, January 1930, page 11.
- Television—1930—J. W. Garside—*Citizens Radio Call Book*, Vol. 11, January 1930, page 123.
- G-E Device Shows Radio in Colors, *Talking Machine and Radio Weekly*, Vol. 29, June 1930, page 37.
- Graf Lens Co. Co-operates with Watson's Television, *Photo-Era*, Vol. 64, January 1930, page 55.
- Grigsby-Grunow and Purdue University Link for Television, *Talking Mach. and Radio Weekly*, Vol. 29, May 14, 1930, page 18.
- Television Forges Ahead—K. A. Hathaway—*Radio News*, Vol. 11, March 1930, page 816.
- Hold Demonstration of Baird Television Sets in New York, *Talking Mach. and Radio Weekly*, Vol. 29, January 1930, page 30.
- How Amateurs are Receiving the Television Broadcast, *Television*, N. Y., Vol. 2, February 1930, page 594.
- How Television is Being Received, *Television*, Lond., Vol. 3, May 1930, page 128.
- Improved Engineering and Standardization of Reproducers and of Television Equipment, *Radio Engineering*, Vol. 10, March 1930, page 43.
- The Development of Television and Radiomovies to Date—C. F. Jenkins—*Soc. Motion Pic. Engrs.*, Vol. 14, March 1930, page 344.
- "P. W.'s" Televisor—G. P. Kendall—*Pop. Wireless*, Vol. 17, April 5, 1930, page 73.
- Die Gebrauchlichsten Arbeitsverfahren beim Fernsehen—G. Kette—*Fernsehen*, Vol. 1, May 1930, page 220. (The most practicable procedures of operation in television.)
- How to Make an Accurate Scanning Disc—A. R. Knipe—*Television*, N. Y., Vol. 2, January 1930, page 547.
- Über Sendermessungen mit dem Rohrenvoltmeter—G. Krawinkel—*Fernsehen*, Vol. 1, May 1930, page 209. (Transmission measurements with a tube voltmeter.)
- La Television en Grande-Bretagne—L. de La Forge—*QST Francais*, Vol. 11, March 1930, page 29.
- Television, Some Suggested Schemes—E. G. Lewin—*Television*, N. Y., Vol. 2, January 1930, page 554.
- Life-sized Images Achieved in Television, *Electrical World*, Vol. 95, May 31, 1930, page 1066.
- The Cathode-Ray Tube in Practical Television—W. G. W. Mitchell—*Television*, N. Y., Vol. 2, February 1930, page 590.
- Mormon Youth Aims to Simplify Television, *Sci. and Inv.*, Vol. 17, April 1930, page 1081.
- Amplifying the Television Signal—C. H. W. Nason—*Radio-Craft*, Vol. 1, March 1930, page 452.
- Pertinent Notes on Characteristics of the Television Signals—C. H. W. Nason—*Radio Broadcast*, Vol. 16, April 1930, page 318.
- A New Cathode-Ray Tube for Television—A. Neuburger—*Television*, Lond., Vol. 3, April 1930, page 99.
- New Cathode Ray Television Set Presents an Eye-ful for a Room Full, *Teleg. and Teleph. Age*, No. 5, March 1, 1930, page 105.
- New Heart for Television, *Radio Retailing*, Vol. 11, January 1930, page 54.
- The New Television Development, *Hardware Age*, Vol. 125, February 27, 1930, page 88.
- New Type of Television Developed by Westinghouse, *Telephony*, Vol. 98, January 11, 1930, page 30.
- New Type of Television, *Tel. Engr.*, Vol. 34, April 1930, page 33.
- Real Images in Pictures Without Film Perform at Television Show, *Exhibitors Herald-World*, Vol. 99, May 31, 1930, page 102.

[Continued on page 48]





## Not Good Enough for Transformers "at War"

"Satisfaction or your money back," "defective parts replaced free," etc., are ample protection for users of civilian goods but with lives and battles depending on Communication Equipment, these peacetime guarantees fail to satisfy. There's no time in a dog-fight to replace a defective transformer, and in battle the only dependable warranty is the assurance that the equipment will *not* fail . . . even under the most abnormal conditions and usage.

Building transformers for aerial communication

is one of Rola's war jobs. *Into* this task goes the knowledge and skill accumulated through years of manufacturing leadership. And *out* of it, certainly, will come new knowledge and new skill for the tasks of Tomorrow.

THE ROLA COMPANY, INC., 2530 Superior Avenue, Cleveland, Ohio.

*In addition to transformers of varying types, Rola manufactures beadsets and coils of all kinds for aerial communications. If your problem involves Electronics . . . and is important to the war effort . . . why not discuss it with a Rola engineer.*

★ ROLA ★

MAKERS OF THE FINEST IN SOUND REPRODUCING AND ELECTRONIC EQUIPMENT

**RADIO**

★ AUGUST, 1943

47

- Details Now Available for Practical Radiovision Reception—D. E. Replogle—*Citizens Radio Call Book*, Vol. 11, March 1930, page 62.
- Image Reception with a Radiovisor—D. E. Replogle—*Radio-Craft*, Vol. 1, March 1930, page 450.
- The New Jenkins Radiovisor—D. E. Replogle—*Radio-Craft*, Vol. 1, February 1930, page 382.
- A Practical Television System—D. E. Replogle—*Projection Engineering*, Vol. 2, May 1930, page 7.
- Where Television is Today—D. E. Replogle—*Radio News*, Vol. 11, January 1930, page 629.
- Low Frequency Amplifiers for Television—W. J. Richardson—*Television*, N. Y., Vol. 2, January 1930, page 564.
- Kompensation der Bildpunktverschiebung beim Fernsehen mit Braunschen Röhren—K. Schlesinger—*Fernsehen*, Vol. 1, May 1930, page 202. (Compensation of the shifting of the point of image in television with a Braun tube.)
- Reproduction and Amplification in Television Receivers—F. Schroter—*Television*, Lond., Vol. 3, April 1930, page 71.
- Television—D. L. Teilhet—*System*, Vol. 57, January 1930, page 29.
- Telephone Company Demonstrates 2-Way Vision, *Radio World*, Vol. 17, April 26, 1930, page 17.
- Telephone Users See Each Other as They Talk, *Pop. Mechanics*, Vol. 53, June 1930, page 892.
- Television Far Off, Says Radio Association Head, *Talking Mach. & Radio Weekly*, Vol. 29, March 12, 1930, page 35.
- Television in Home Now Likely, But Won't Affect Theatre, Schmitzer Holds, *Exhibitors Herald-World*, Vol. 99, May 3, 1930, page 22.
- Television in the Theatre, *Electronics*, Vol. 1, June 1930, page 147.
- Television Picture Flashed to Australia and Back in One-Eighth of a Second, *Tele. and Teleph. Age*, No. 5, March 1, 1930, page 110.
- Television, Present and Future, *Engineering*, Vol. 129, March 14, 1930, page 343.
- Television Schedule, *Radio Broadcast*, Vol. 16, February 1930, page 238.
- Television Sent Over 20,000 Miles, *Exhibitors Herald-World*, Vol. 98, March 1, 1930, page 47.
- Television Signals Transmitted 20,000 Miles, *Projection Engineering*, Vol. 2, April 1930, page 29.
- Television Store Will Be Located in Evanston, *Exhibitors Herald-World*, Vol. 99, May 17, 1930, page 21.
- Television Systems, *Exp. Wireless*, Vol. 7, January 1930, page 26.
- The Origin and Progress of Television—C. Tierney—*Television*, Lond., Vol. 2, January 1930, page 543.
- Two-way Television, *Sci. Monthly*, Vol. 30, May 1930, page 476.
- Experimental Television Apparatus—A. A. Waters—*Television*, Lond., Vol. 2, January 1930, page 570.
- Television for the Beginner—J. W. Woodford—*Television*, N. Y., Vol. 2, January 1930, page 572.
- Cathode-Ray Tube Television—V. Zworykin—*Citizens Radio Call Book*, Vol. 11, January 1930, page 90.
- Television Through a Crystal Globe—V. Zworykin—*Radio News*, Vol. 11, April 1930, page 905.
- Experimental Television Apparatus—A. A. Waters—*Television*, N. Y., Vol. 2, February 1930, page 596.
- Color Television Reported on Way, *Tel. Engr.*, Vol. 34, March 1930, page 40.
- Television Images in Natural Colors—H. E. Ives—*Radio-Craft*, Vol. 1, January 1930, page 316.
- Television in Colors by a Beam Scanning Method—H. E. Ives and A. L. Johnrud—*Jour. Opt. Soc. Amer.*, Vol. 20, January 1930, page 11.
- Ferbiges Fernsehen — A. Neuburger — *Fernsehen*, Vol. 1, February 1930, page 63. (Color Television.)
- Television in Germany—A. V. F. V. Russell—*Television*, Lond., Vol. 3, March 1930, page 10.
- Photoelectric Cells & Method of Coupling to V.T.—Dewhurst—*QST*, June 1929, page 17.
- Direct Scanning in Television—F. Gray—*Bell Lab. Record*, Vol. VII, No. 7, March 1929, page 276.
- The Light of a Television Eye—F. Gray—*Bell Lab. Record*, Vol. VI, No. 4, June 1928, page 325.
- Television in Colors—H. E. Ives—*Bell Lab. Record*, Vol. VII, No. 11, July 1929, page 439.
- The Television Timer—H. M. Stoller—*Bell Lab. Record*, Vol. IV, No. 5, July 1929, page 386.
- The Fight for British Television—W. B. Abbott—*Television*, Lond., Vol. 2, November 1929, page 468.
- Aerial "Eyes" for Future Wars, *Sci. and Inv.*, Vol. 17, July 1929, page 247.
- Aerial Television, *Aero Digest*, Vol. 15, July 1929, page 174.
- L'amplification dans la Television—G. H. d'Ailly—*QST Francais*, Vol. 10, March 1929, page 45.
- The Detection of Small Quantities of Light—E. E. Fournier d'Albe—*Television*, Lond., Vol. 2, August 1929, page 317.
- And Now—Television in Color, *Transmitter*, Vol. 17, August 1929, page 19.
- Now—Television in Natural Colors—A. P. Armagnac—*Pop. Sci.*, Vol. 115, September 1929, page 25.
- Radio Picture Transmission and Reception—J. P. Arnold—*Radio*, Vol. 11, June 1929, page 21.
- Television in Natural Colors—J. P. Arnold—*Radio*, Vol. 11, October 1929, page 35.
- Visual Communication—J. P. Arnold—*Projection Engineering*, Vol. 1, September 1929, page 23.
- Visual Transmission—J. P. Arnold—*Radio*, Vol. 11, August 1929, page 78.
- B. B. C. Transmission, *Electrical Rev.*, Lond., Vol. 105, October 11, 1929, page 108.
- Baird Apparatus in German G. P. O., *Television*, Lond., Vol. 2, July 1929, page 244.
- Tune in Television Waves with Your Present Receiver—H. S. Baird—*Television*, N. Y., Vol. 1, January-February 1929, page 87.
- Baird Television Ready for Proof, *Radio World*, Vol. 16, December 7, 1929, page 21.
- Bell Laboratories Scientists Achieve Color Television, *New Jersey Bell*, Vol. 2, August 1929, page 5.
- Bell Telephone Laboratories Engineers Transmit and Reproduce Scenes in Their Natural Hues, *Wisconsin Tel. News*, Vol. 24, August 1929, page 19.
- Synchronization Still is a Television Problem—T. W. Benson—*Radio News*, Vol. 11, August 1929, page 115.
- Photographing a Television Image—A. F. Birch—*Television*, Lond., Vol. 2, November 1929, page 448.
- Radiophonie et Radiovision Transformerontelles le Journal?—C. Brachet—*La Science et la Vie*, Vol. 36, December 1929, page 493. (Will radio and television transform the newspapers?)
- Television First with the News—W. J. Brittain—*Television*, Lond., Vol. 1, January 1929, page 14.
- Builds "Aerial Eye" for Tests in Plane, *Aviation*, Vol. 26, April 27, 1929, page 9437.
- Practical Television and Its Problems—A. A. Campbell Swinton—*Nature*, Vol. 123, March 23, 1929, page 449.
- Television: Past and Future—A. A. Campbell Swinton—*Exp. Wireless*, Vol. 6, January 1929, page 46.
- Capturing the Rainbow: Television Hits a High Note, *Tel. News*, Vol. 25, August 1929, page 32.
- Your First Television Set—J. Carr—*Pop. Sci.*, Vol. 115, January 1929, page 65.
- Cathode Ray Replaces Disk, *Radio World*, Vol. 16, December 7, 1929, page 21.
- More Light Through the Scanning Disc—G. C. Cato—*Television*, Lond., Vol. 2, December 1929, page 519.
- Television and Your Wireless Receiver—B. H. J. Chapple—*Television*, Lond., Vol. 2, October 1929, page 413.
- Mastering the Optics of Television—Cheshire—*Television*, N. Y., Vol. 1, March-April 1929, page 104.
- Optics for Television Experimenters—Cheshire—*Television*, N. Y., Vol. 1, January-February 1929, page 69.
- Television and the Amateur—A. Church—*Television*, Lond., Vol. 1, January 1929, page 33.
- Synchronizing Television with Light Beams—P. L. Clark—*Television*, N. Y., Vol. 1, January-February 1929, page 56.
- Television Light Modulator—P. L. Clark—*Sci. and Inv.*, Vol. 16, February 1929, page 950.
- Clear Images 10" Square in New Television, *Radio World*, Vol. 14, March 23, 1929, page 5.
- Color Television, *W. E. News*, Vol. 18, August 1929, page 18.
- Color Television, *Science*, Vol. 70, July 5, 1929.
- Color Television Magic, *Exhibitors Herald-World*, Vol. 96, July 15, 1929, page 24.
- Color Television Makes American Debut, *Science News Letter*, Vol. 16, July 6, 1929, page 3.
- Colored Television Shown by Bell Laboratories, *Electrical Record*, Vol. 46, August 1929, page 91.
- Coloring the Picture, *Long Lines*, Vol. 9, August 1929, page 6.
- Complete Television Receiver, *Sci. and Inv.*, Vol. 16, January 1929, page 841.

[Continued on page 50]



# Nelson Did Not Have RACONS



Lord Nelson's commands were given by blinker light, signal flag or megaphone. Such undependable means of communications often caused great loss of life — even the loss of battles. But times change!

Now-a-days our fighting men at sea — on all types of vessels — are afforded great protection by many types of RACON loudspeakers and driving units.

On land, too, RACONS do their bit. They are preferred by sound experts who know RACONS deliver greater output per watt of energy input — they are most efficient and dependable. Competitively priced, RACONS may be obtained for shipyard, industrial war plant and similar important sound installations. There is a RACON for every conceivable application. Get further particulars today.



**MARINE HORN  
SPEAKER**



**RE-ENTRANT  
TRUMPETS**

Here are but two of the many RACON Speakers. The Marine Horn Speaker is of the re-entrant type, for marine and general p-a applications. Available in several sizes, from 5 to 50 watts, they may be used as loud-speaker or as microphone. Approved by the U. S. Coast Guard, (formerly the Bur. of Marine Inspection, Dep't of Commerce.) RACON Re-entrant Trumpets occupy small space but afford a long horn that carries highly concentrated sound efficiently over long distances. Several sizes available.

RACON ELECTRIC CO., 52 East 19th St., New York, N. Y.

# RACON

- How to Drill Scanning Discs in Jig Time—P. E. Cushman—*Television*, N. Y., Vol. 1, January-February 1929, page 58.
- How to Make Scanning Discs with Square Holes—P. E. Cushman—*Television*, N. Y., Vol. 1, March-April 1929, page 122.
- D. F. Goldman Declares Television is Years Off, *Talking Mach. & Radio Weekly*, Vol. 28, December 4, 1929, page 37.
- DeForest Shows New Jenkins Television Set at Chicago Show, *Talking Mach. & Radio Weekly*, Vol. 28, October 30, 1929, page 9.
- The Television Society Report of January Meeting—J. Denton—*Television*, N. Y., Vol. 1, February 1929, page 28.
- Dr. Alexanderson Puts Television Pictures on the Wall—M. Dunn—*Television*, N. Y., Vol. 1, January-February 1929, page 64.
- Der Fernscher Telefunken-Karolus, *E.T.Z.*, Vol. 50, May 23, 1929, page 761. (The Radio-Karolus televisor.)
- How Television Will Kill "Time"—S. Desmond—*Television*, Lond., Vol. 2, September 1929, page 341.
- Indexing Head for Highly Accurate Spacing—F. C. Duston—*Machinery*, Vol. 36, September 1929, page 14.
- Television Today—P. P. Eckersley—*Pop. Wireless*, Vol. 16, September 28, 1929, page 125.
- This Television Business—P. P. Eckersley—*Pop. Wireless*, Vol. 16, December 14, 1929, page 781.
- Transmission of Television Images—P. T. Farnsworth and H. R. Lubcke—*Radio*, Vol. 11, December 1929, page 36.
- First Television Demonstration in South Africa, *Television*, Lond., Vol. 2, September 1929, page 328.
- Colored Television—N. Fitzalan—*Radio World*, Vol. 15, July 20, 1929, page 11.
- Sharp Television 15 x 18"—N. Fitzalan—*Radio World*, Vol. 15, April 27, 1929, page 21.
- Television Stressed by Engineers—Encouraged by Aspects—N. Fitzalan—*Radio World*, Vol. 16, September 28, 1929, page 5.
- The B. B. C. and Television—A. Fleming—*Television*, Lond., Vol. 2, September 1929, page 325.
- Comparative Tests of Television Apparatus—A. Fleming—*Television*, Lond., Vol. 2, June 1929, page 161.
- What Television Experimenters Should Know About Radiation—A. Fleming—*Television*, N. Y., Vol. 1, January-February 1929, page 65.
- Educational Uses for Television—A. Fleming—*Television*, Lond., Vol. 2, December 1929, page 477.
- L'Etat Actuel des Procédes Baird—L. de LaForge—*QST Français*, Vol. 10, June 1929, page 35. (The actual stage of the Baird procedures.)
- Le Transmission des Images par la "Radio" est Une Etape vers la Television—L. Fournier—*La Science et la Vie*, Vol. 35, May 1929, page 395. (The transmission of images by means of radio is a stage towards television.)
- Some Notes on Exploring Discs and Their Construction—W. C. Fox—*Television*, Lond., Vol. 2, July 1929, page 247.
- Cone Pulleys Solve Television Synchronizing—C. S. Gleason—*Radio-Craft*, Vol. 1, September 1929, page 114.
- High Frequencies for Color Television—C. S. Gleason—*Radio News*, Vol. 10, January 1929, page 632.
- Mihaly's Tele-Cinema—Dr. A. Gradenwitz—*Television*, Lond., Vol. 2, April 1929, page 59.
- Television Progress in Germany—Dr. A. Gradenwitz—*Television*, Lond., Vol. 2, June 1929, page 165.
- Television in Czecho-Slovakia—Dr. A. Gradenwitz—*Television*, Lond., Vol. 2, December 1929, page 522.
- Direct Scanning in Television—F. Gray—*Bell Lab. Record*, Vol. 7, March 1929, page 276.
- Optical Conditions for Direct Scanning in Television—F. Gray and H. E. Ives—*Jour. Opt. Soc. Amer.*, Vol. 18, March 1929, page 21651.
- The Race for Television—A. A. Gulliland—*Pop. Wireless*, Vol. 15, August 3, 1929, page 659.
- Television in Germany—A. A. Gulliland—*Pop. Wireless*, Vol. 15, June 15, 1929, page 445.
- The Psychology of Empire Television—H. A. Hankey—*Television*, Lond., Vol. 2, June 1929, page 204.
- The Literature of Television—J. H. O. Harries—*Television*, Lond., Vol. 2, September 1929, page 345.
- A Quantitative Analysis of Television—J. H. O. Harries—*Television*, Lond., Vol. 2, May 1929, page 105.
- A Television Reception Test—F. H. Haynes—*Wireless World*, Vol. 25, December 18, 1929, page 669.
- Television; the Latest Developments in the Field—R. Hertzberg—*Radio News*, Vol. 10, January 1929, page 630.
- Home Television Before Christmas?, *Elec. Merchandising*, Vol. 42, October 1929, page 108.
- How the Jenkins Radio Movies Work, *Radio Retailing*, Vol. 9, February 1929, page 79.
- Improved Television of "I. C. A." Wins Plaudits, *Radio Retailer and Jobber*, Vol. 7, January 1929, page 28.
- Inauguration of Television Broadcasting Service in Great Britain, *Nature*, Vol. 123, March 16, 1929, page 422.
- New Television System Minus Disks, *Pop. Science*, Vol. 115, January 1929, page 61.
- Invisible Ray Transmits Pictures, *Sci. and Inv.*, Vol. 17, November 1929, page 629.
- Television Demonstration—H. E. Ives—*Jour. S.M.P.E.*, Vol. 13, No. 38, May 1929, page 308.
- Television in Color—H. E. Ives—*Sci. and Inv.*, Vol. 17, September 1929, page 400.
- Adjusting and Receiving Apparatus of the Color Television System—H. E. Ives and A. L. Johnsrud—*Southwestern Tel. News*, Vol. 16, August 1929, page 10.
- Television in Color by a Beam Scanning Method—H. E. Ives and A. L. Johnsrud—*Jour. Opt. Soc. Amer.*, October 1929, page 8.
- The Drum Scanner in Radiomovie Receivers—C. F. Jenkins—*Proceedings IRE*, Vol. 17, September 1929, page 1576.
- "Jenkins Discusses Television"—C. F. Jenkins—*Radio Digest*, Vol. 23, March 1929, page 49.
- Jenkins Tells Why "Shadows" Are Used, *Radio World*, Vol. 14, February 16, 1929, page 13.
- Radio Finds Its Eyes—C. F. Jenkins—*Saturday Evening Post*, Vol. 202, July 27, 1929, page 12.
- Die 6. Grosse Deutsche Funkausstellung—G. Kette—*T.F.T.*, Vol. 18, September 1929, page 294.
- "Television Soon"—H. A. Lafount—*Radio World*, Vol. 16, November 23, 1929, page 8.
- The Proceedings of the Television Society—F. Langford-Smith—*Television*, Lond., Vol. 2, December 1929, page 506.
- Large Television Images Broadcast by R. C. A., *Radio News*, Vol. 10, June 1929, page 1121.
- Latest Radiovision News, *Sci. and Inv.*, Vol. 17, June 1929, page 151.
- Television in the Making; Two Definite Schools of Research and Engineering Development and What They Mean to the Future of This Young Art—A. C. Lescarboursa—*Projection Eng.*, Vol. 1, September 1929, page 21.
- Television in Colors—S. K. Lewer—*Science Progress*, Vol. 24, October 1929, page 316.
- Liquid Light-Cell, *Sci. and Inv.*, Vol. 16, January 1929, page 840.
- Forward! The Progress of Television in Germany—S. Loewe and P. Goertz—*Television*, Lond., Vol. 2, November 1929, page 428.
- The Lower Frequencies in Television, *Television*, Lond., Vol. 2, December 1929, page 518.
- A Woman's View of Television—Bertha Lupton—*Television*, Lond., Vol. 1, February 1929, page 21.
- What Are the Facts About Television?—A. H. Lynch and C. F. Jenkins—*Radio News*, Vol. 11, August 1929, page 124.
- Broadcasting and Television—E. R. MacPerson—*Television*, Lond., Vol. 2, May 1929, page 151.
- Making Accurate Television Disks—W. E. McArdeil—*Am. Mach.*, Vol. 70, June 20, 1929, page 986.
- Kerr Cell Feature of Karolus Television—M. Mapes—*Television*, N. Y., Vol. 1, January-February 1929, page 62.
- The Future Developments of Television—C. Malone—*Television*, Lond., Vol. 2, May 1929, page 115.
- America's Television Experiments—J. Marsham—*Pop. Wireless*, Vol. 15, March 30, 1929, page 85.
- A Simple Shadowgraph Transmitter—E. V. R. Martin—*Television*, Lond., Vol. 2, March 1929, page 23.
- Giving Television the "Last Touches"—C. P. Mason—*Radio News*, Vol. 10, January 1929, page 634.
- Explanation of Television—J. Mills—*W. E. News*, Vol. 17, January 1929, page 19.
- Through Electrical Eyes—J. Mills—*W. E. News*, Vol. 18, March 1929, page 28.
- The Cathode-Ray Tube in Practical Television—W. G. W. Mitchell—*Television*, Lond., Vol. 2, May 1929, page 129.

[To be continued]





# STEATITE

*by Centralab*

No Shortage • Ample Capacity  
Custom - Made to Your  
Requirements

# Centralab

Division of GLOBE-UNION INC., Milwaukee

# THIS MONTH

## "E" STAR FOR GENERAL RADIO

The General Radio Company, of Cambridge, Massachusetts, has been awarded a star for their "E" pennant, signifying a renewal of the Army-Navy Production Award for a six-months' period dating from June 15, 1943.

★

## JENSEN EMPLOYEES HEAR U. S. HEROES

Two heroes of our armed forces gave the employees of Jensen Radio Manufacturing Company a vivid description of some of the hardships which are the everyday lot of our country's fighting men.

The two men, both of whom have been decorated with the Order of the Purple Heart for outstanding bravery beyond the call of duty, are Fireman 1st Class Arthur W. Ambler of the U. S. Navy, and Sergeant John E. Barry of the U. S. Marines.

Both men were wounded in action after being in some of the most desper-



T. A. White, Jensen Vice President, with visiting war heroes.

ate fighting that the south Pacific has witnessed

Sergeant Barry was on the Wasp when she went down, and also was with the first U. S. Marines to land on

Guadalcanal. Fireman Ambler was on two ships that went down, the Lexington and the Yorktown. The program was arranged by the U. S. Navy, and conducted by Yeoman Shelby Pitts.

★

## LAFAYETTE EXPANDS SCHOOL DIVISION

The Schools Division of Lafayette Radio Corp., headed by Arthur J. Rattray, has recently been enlarged and expanded. This department was established to give consultation service to schools and colleges on radio training programs and engineering problems. The services of the Schools Division have become so popular since the beginning of the war that it has been found necessary greatly to increase its size and scope to keep up with demands.

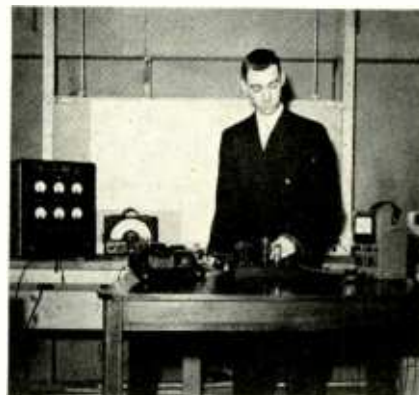

Arthur J. Rattray.

The facilities of the Schools Division, under the supervision of Mr. Rattray are open to all schools and colleges. Particular emphasis is placed on Government training projects relative to all branches of physics, radio and electronics. A timely new brochure on radio training kits is now offered—free for the asking—as well as schematic diagrams, radio parts catalog, etc. Lafayette engineers, through the Schools Division, offer advice in planning training courses and in designing electronic equipment for special applications. Mr. Rattray and the Schools Division personnel are looking forward to a very busy fall and winter season.

★

## NEW PHILIPS TRADEMARK

North American Philips Company, Inc., with main office and factory at  
[Continued on page 65]

## SHURE EQUIPMENT AT CASABLANCA



Here is a happy group at Shure Brothers, with Jack Berman, Sales Manager, displaying a photo of historical value. It pictures General Mark W. Clark and General Nogues witnessing the important ceremonies when American fighting materials were turned over to the French. Encircled in the photo is an integral part of this fighting equipment—a boxed Shure Microphone, ready to carry its messages of Hope and Victory.



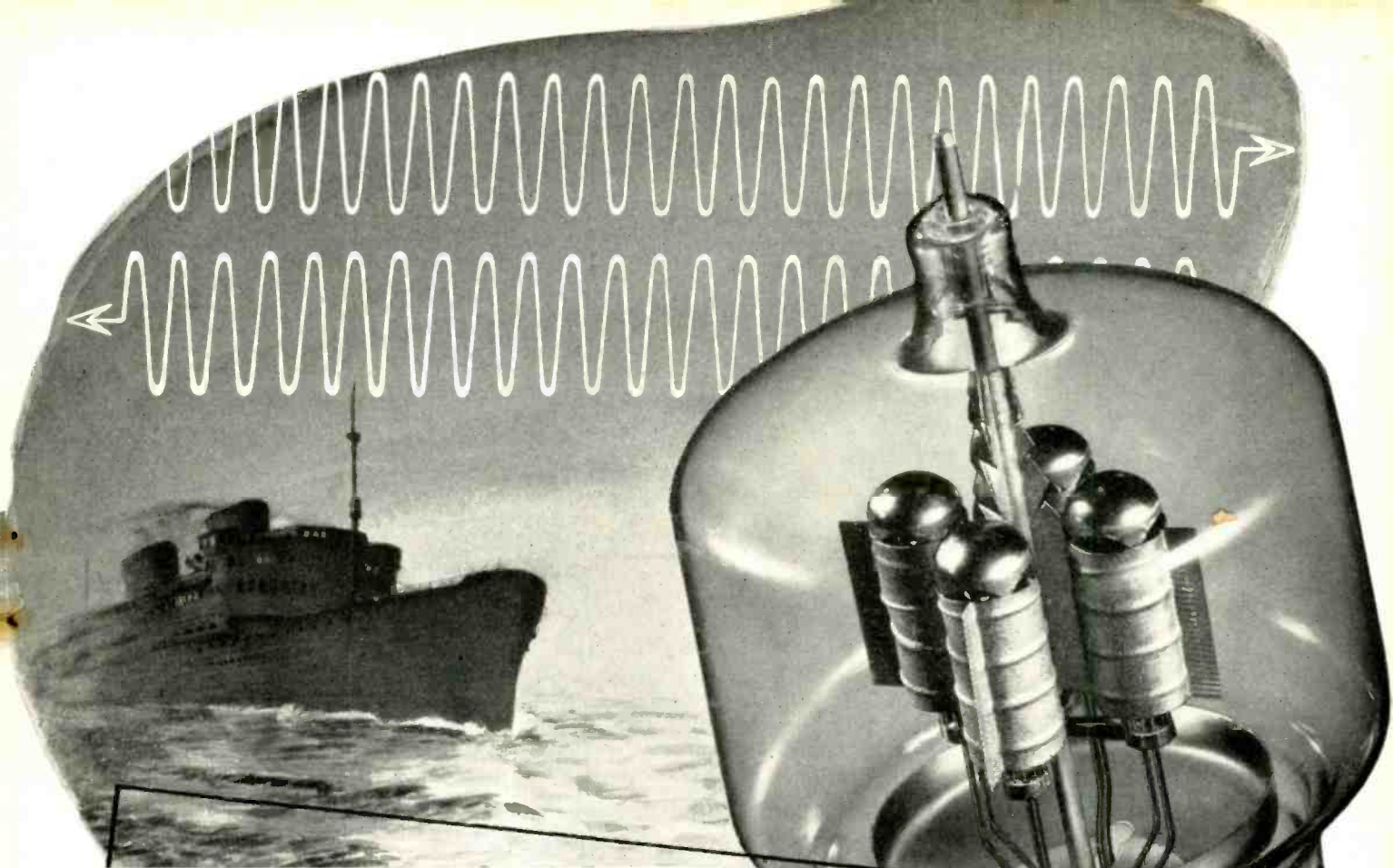

## electronic briefs: **radar**

Radar is a method of transmitting ultra-high-frequency radio waves to an object which reflects the wave back to its source. The time required for the round trip from the transmitter to the object and back to the receiver is the measure of the distance to the object. The direction is established through the use of directional wave transmission.

High transmitter power is essential in radar for the amount of energy which is reflected is extremely small. Plate voltages are in the order of tens of thousands of volts and plate currents are measured in tens of amperes. The vacuum tubes used in such equipment must be capable of operating efficiently and dependably over long periods under extremely heavy loads.

High voltage, high frequency, operation at absolute peak emission...ability to stand momentary overloads of as much as 400%...unconditional guarantee against emission failure due to gas released internally...are the features which marked Eimac tubes as ideal for this important application. These are some of the reasons why Eimac has been "Standard" in Radar transmitters for the past number of years. Just one more proof that Eimac tubes are first in the important new developments in electronics.

EIMAC  
304T

**EITEL-McCULLOUGH, Inc.**  
SAN BRUNO, CALIFORNIA

Export Agents: Frazar & Hansen  
301 Clay Street, San Francisco, California, U. S. A.

Follow the leaders to



Awarded for high achievement in the production of war materials.

**Eimac**  
REG. U. S. PAT. & TM. OFF.  
**TUBES**

# NEW PRODUCTS

## ROTOBRIDGE CIRCUIT TESTER

Rotobridge, the automatic high-speed mass production tester, offers important advantages to test and production engineers faced with the necessity of using unskilled labor for factory circuit checking. With the Rotobridge it is possible to attain Wheatstone bridge precision while testing circuits at the rate of one circuit per second. Skilled labor and engineering personnel may be released for other duties since Rotobridge requires only one set up; now in use by scores of war production plants, testing all types of communication, electronic and electrical equipment for errors in resistance, reactance, and in circuit wiring. Since the human element is almost completely eliminated, specified tolerances are absolutely maintained.



Communication Measurements Laboratory, 116 Greenwich St., New York. Rotobridge designers and manufacturers, also have available a new model, which is especially interesting to companies producing aircraft, tanks, switchboards, etc. Its use enables testing of multi-wire cable harnesses with amazing speed: up to 120 circuits (including several hundred wires) may be tested at once, in 4-minutes operating time. Illustrated bulletins giving the complete Rotobridge story are available from the New York office of the manufacturer.

★

## ROTOM MOTOR

A small, self-starting, constant speed motor, that maintains superior speed regulation under wide variations of voltage, load, and temperature, is being made by the Rotom Manufacturing Company of Alhambra, California.

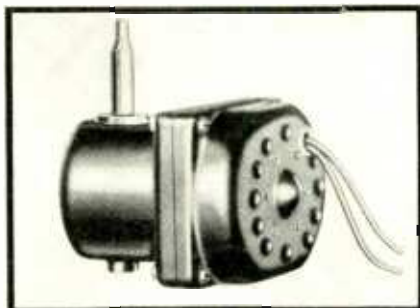

Measuring only  $4\frac{3}{8} \times 3\frac{1}{8} \times 3\frac{1}{4}$ ", this Rotom Motor is available for operation on 110 or 220 volt, 50 or 60 cycle source at 14 watts input. Gears are of helical-cut laminated bakelite for quiet operation and are completely enclosed and protected. Forced ventilation assures cool operation. The motor has large bearings and ample oil reserves and is precision assembled for uniform production. Shipping weight of this Rotom Motor is but  $\frac{5}{2}$  pounds.

★

## TWO-TERMINAL OIL CAPACITOR

Already a highly popular type of oil capacitor because of its handy inverted screw mounting and compact dimensions, the Aerovox Type 10 is now further improved by the new double-terminal feature. Heretofore this capacitor has had a single insulated terminal and grounded can, although when screw-mounted on a metal chassis it could be fully insulated by an insulating washer.

The new double-terminal feature means that both terminal lugs are insulated from the "floating" can and no insulating washer is required. These capacitors, made by Aerovox Corporation of New Bedford, Mass., are hermetically sealed and will pass all immersion tests required by Governmental agencies. This is accomplished by the use of the new one-piece molded bake-

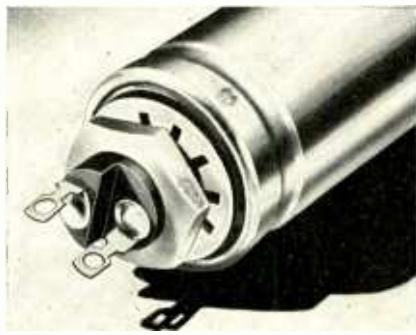

lite terminal assembly which prevents penetration of moisture and leakage of oil. These capacitors, available on high priorities only, are filled with either Hyvol vegetable oil or mineral oil, rated up to 4.0 mfd. at 600 v. d.c. and to .5 mfd. at 1500 v. d.c. The can, similar in design and dimensions to the usual inverted-screw-mounting metal-can electrolytics, is of aluminum or an approved substitute.

★

## NEW GAS-TIGHT TERMINAL

Here is a 100% gas-tight terminal, developed for use on radio coaxial cables, but equally applicable in many other places where an insulated termi-

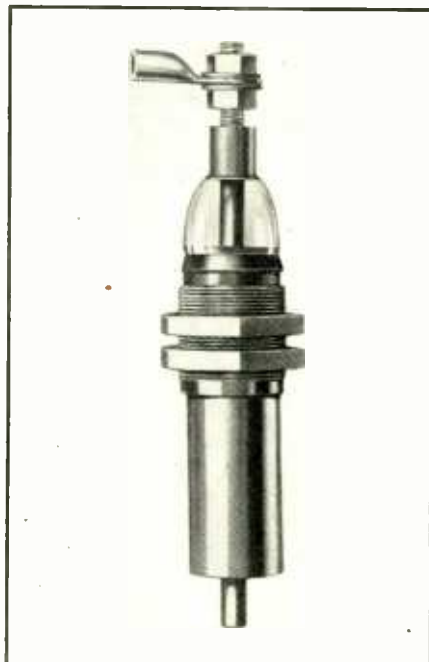

nal is required for equipment in a sealed container. The seal is obtained by fusion of glass to metal. A metal alloy of suitable coefficient of expansion is used.

The unit shown is installed on the end of a  $\frac{7}{8}$ " coaxial cable. Other sizes are available. Manufactured by Victor J. Andrew Co., 363 East 75th Street, Chicago, Ill.

★

## NEW TRACING CLOTH

The Frederick Post Company of Chicago has just recently developed a new greatly improved White Pencil Tracing Cloth—"Whitex."

[Continued on page 65]



## WEATHER FORECASTING

[Continued from page 35]

- 8—Some Notes on U.H.F. Propagation—H. H. Beverage—*RCA Review*, Vol. 5, July, 1940, page 97.
- 9—The Coincidence of U.H.F. Fading—Perry Ferrell, Jr.—*Radio*, April, 1941, page 9.
- 10—5 Meter Wave-Paths—M. S. Wilson—*QST*, August, 1941, page 23.
- 11—Weak Signal FM Reception—Perry Ferrell, Jr.—*Radio*, December, 1940, page 5.
- 12—Notes on U.H.F. Propagation—Perry Ferrell, Jr.—*Radio*, March, 1942, page 6.
- 13—Stability of Two-Meter Waves—Burrows, Decino and Hunt—*Proceedings IRE*, Vol. 26, May, 1938, page 516.
- 14—Listening on Ultra-Highs—Perry Ferrell, Jr.—*Australasian Radio World*, February, 1939, page 25.
- 15—FM Field Tests, *RCA Review*, October, 1940, page 190.
- 16—Field Tests of Frequency and Amplitude Modulation—J. R. Weir—*General Electric Review*, May, 1939, Part 1; June, 1939, Part 2.
- 17—Propagation of Ultra-Short Waves—Smith and Rose—*Journal Television Society*, Vol. 2, December, 1938, page 475.
- 18—The monthly Columns by E. H. Conklin and E. Tilton appearing in *Radio* and *QST* respectively, between 1937 and 1941.

## DESIGN WORKSHEET

[Continued from page 40]

a pair of first-order side frequencies:

$$\frac{AK\theta}{2} \sin(\omega t + \theta - pt) \text{ and}$$

$$\frac{AK\theta}{2} \sin(\omega t + \theta - pt)$$

and a pair of second-order frequencies:

$$\frac{AK^2\theta^2}{8} \cos(\omega t + \theta + 2pt) \text{ and}$$

$$\frac{AK^2\theta^2}{8} \cos(\omega t - \theta - 2pt)$$

symmetrically disposed about the carrier. Had other terms been expanded, other higher order side frequencies would have resulted. Actually the number of side frequencies is infinite. Practically this means a wider band than amplitude modulation but not an infinite bandwidth. Some of the important side frequencies may have amplitudes equal to or greater than that of the carrier.

Another important characteristic of phase modulation is that the bandwidth varies in proportion to the frequency of the modulating signal. It is also interesting to note that the carrier and first-order side frequencies are displaced  $\pi/2$  radians from their position in an amplitude-modulated wave (Radio Design Worksheet No. 11, page

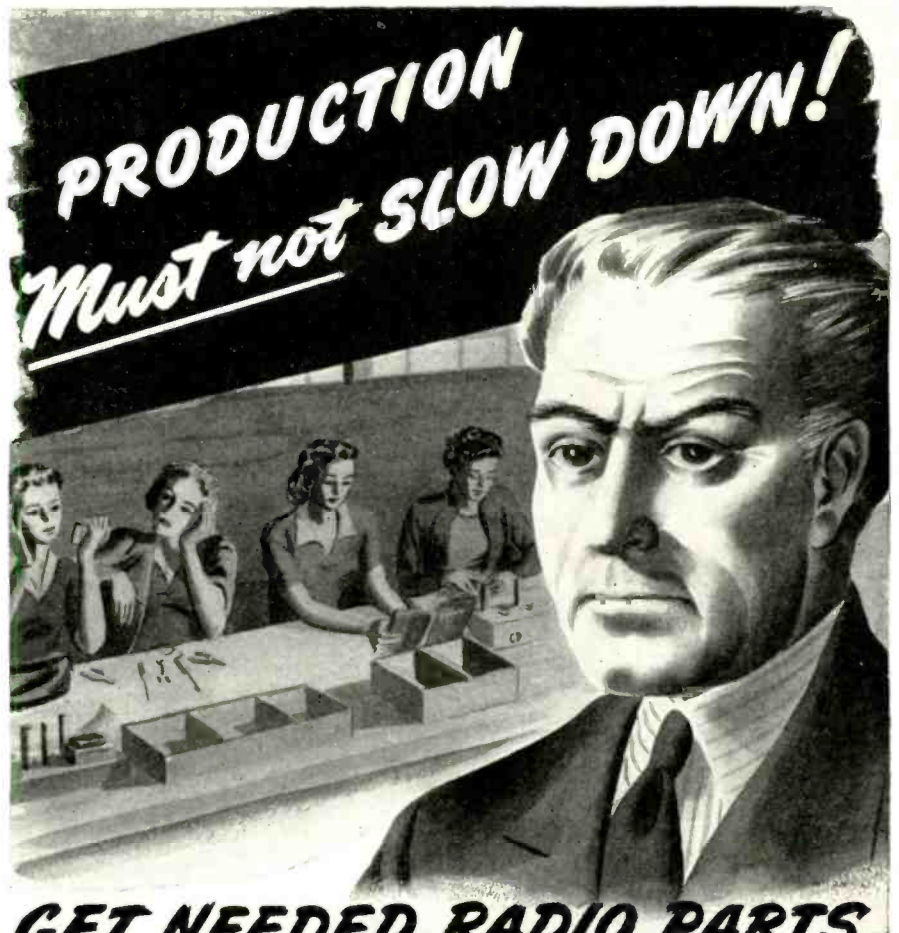

# GET NEEDED RADIO PARTS Quickly!

Don't allow *your* production lines to slow down for lack of essential parts. Lafayette Radio Corp. is headquarters for all radio and electronic parts and equipment of every nationally known manufacturer in the field. Let Lafayette help you keep your production humming and save *your* time—one single order to Lafayette will insure *prompt* delivery on all hard-to-get parts and equipment your program may require.

Thousands of manufacturers, electronic engineers and private and military training program directors know Lafayette's reputation for complete stocks and extensive procurement facilities. We can fill *your* needs too—*quickly!*

Write today for Free 130 page Radio and Electronic Parts and Equipment Catalog—  
Address Dept. 8F3



## LAFAYETTE RADIO CORP.

★ 901 W. JACKSON BLVD.

★ 265 PEACHTREE STREET

CHICAGO, ILLINOIS

ATLANTA, GEORGIA





# Keep 'Em Running FOR THE DURATION!

It is difficult to secure new Generating Sets or new Rotary Converters . . . Pioneer is devoting all of its resources toward winning the war . . . but we can, and will, help you keep your present equipment running for the duration. Send your service problems, by letter, to Pioneer's Customer Service Department.

DYNAMOTORS · CONVERTERS · GENERATORS · DC MOTORS · POWER PLANTS  
GEN-E-MOTORS

## PINCOR Products

CHICAGO, ILLINOIS · EXPORT ADDRESS: 25 W. ARREN STREET, NEW YORK CITY  
CABLE ADDRESS: SIMONTRICE, NEW YORK CITY

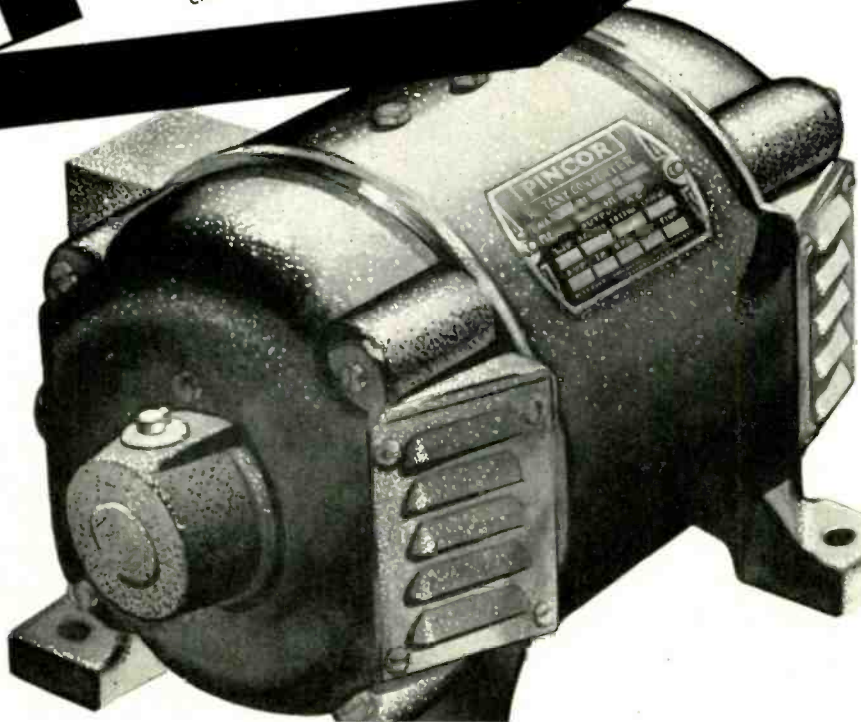

30, March 1943 RADIO). This is true of all odd-order side frequencies. Thus if the carrier and first-order side frequencies alone of a phase-modulated wave were applied to an ordinary detector no signal output would result. If carrier and all side frequencies of a phase-modulated wave were applied to an ordinary detector, only harmonics of the signal would result. However, in spite of these peculiarities there are many advantages of phase modulation which will be shown in later Worksheets.

Perhaps a better physical picture of phase modulation will result from a study of Fig. 1. In this figure the vector  $oA$ , represents a radio-frequency signal which is rotating about  $o$ , making one complete revolution per radio-frequency cycle. Assume the vector is rotating in a counter-clockwise direction but the phase modulation causes it to oscillate during rotation over an angle  $\theta$ . The two dotted vectors represent the limits of the oscillation of vector  $oA$ . The average speed of rotation of the vector is constant, but its instantaneous speed is variable, alternately slowing down and speeding up compared to the average speed of rotation. The magnitude of phase swing  $\theta$  is determined by the amplitude of the modulating signal and the velocity with which the vector oscillates by the frequency of the modulating signal.

### OPERATING STANDARDS

[Continued from page 29]

side causes no splatter or channel interference. Thus the full modulation capabilities of a transmitter may be realized from uni-directional microphones when they are poled at the studio with this purpose in mind.

The transmitter operator can, of course, accomplish the same end at the transmitter by using a patch-cord between line and amplifier jacks in such a way as to reverse the line terminations when maximum peak energy is on the negative side. By keeping the maximum peak on the positive side of the modulated envelope, it may be seen that a considerable increase in level may be realized over that amount that could be tolerated if the maximum peaks were on the negative side.

As to the problem of difference in "loudness sensation" for a given meter reading between two or more voices, a brief perusal of the situation will emphasize the magnitude of its importance, and should constitute a challenge to operators and engineers to correlate existing facts with operational procedure.

Fig. 5 is a graph of loudness level



curves as adopted by the American Standards Association. The derivation of these curves is explained in most standard textbooks on sound, and will not be explained here. An example will suffice to enable the reader to correctly use this graph.

#### Loudness Level Curves

It will be noted that (for example) a tone of 300 cycles 40 db above the reference level (0 db), corresponds to a point on the curve marked 30. This is, then, the loudness level. It means that the intensity level of a 1000-cycle tone (reference frequency) would be only 30 db in order to sound equally as loud as the 40-db, 300-cycle tone.

Now assuming a fundamental tone of 392 cycles, (G string of a violin) with an actual intensity of 40 db above reference level, it will be noted from the graph that the loudness level is approximately 36 db. It was determined in Bell Laboratories that the addition of the overtones or harmonics of the fundamental, raised the intensity from 40 to 40.9 db, whereas the loudness level was raised from 36 to 44 db. In other words, the addition of the harmonics raises the actual meter reading only 0.9 db, while the loudness level increases 8 db. For the complex tone, the reference level of 1000 cycles would be 44 db to sound equally as loud.

When it is realized that vocal organs of human beings are all exceedingly different, and are associated with a particular resonating apparatus that gives to the voice its individual timbre, it becomes clear why it often occurs that two voices peaked at a given meter reading will sound far different in loudness. Certain harmonics of the voice are emphasized, while others are suppressed in an infinite variety of degrees. A study of Fig. 6, which is a graphical integration from an actual oscillograph of two male voices intoning the same vowel (ah) at the same frequency, will reveal a decided difference in peak factor (ratio of peak to average content) which in turn depends to a large extent on harmonic content and phase relationship of the harmonics to the fundamental.

#### Operator's Judgment

At the present time, only one solution suggests itself. When it becomes necessary to transmit two voices of such difference in character as to be decidedly unequal in loudness for a given reference level, the good taste and judgment of the operator at the control panel must govern their respective levels. The author fully realizes the many and varied complications that arise from this decision, since loudness is not only a physical but also a

[Continued on page 59]

*a Star Has Been Added*

☆ **SYMBOLIZING  
continued EXCELLENCE  
IN WAR PRODUCTION**

TYPE B5  
**BLILEY**  
FREQUENCY CONTROL  
SERIAL NUMBER  
**R19655**  
FREQUENCY  
**7115 KC**  
MADE IN U.S.A.  
ERIE, PA.

BLILEY ELECTRIC COMPANY · · · ERIE, PA.

*Bliley Crystals*

# IF YOU'RE MAKING MORE MONEY

## ...WATCH OUT!



**WE WANT TO WARN YOU**, before you read this page, that you've got to use your head to understand it.

We also want to warn you that—if you don't bother to read it carefully enough to understand it—you may wake up after this war as poor as a church mouse.

This year Americans are going to make —minus taxes—125 billion dollars.



But this year, we civilians are not going to have 125 billion dollars' worth of goods to spend this on. We're only going to have 80 billion dollars' worth. The rest of our goods are being used to fight the war.

That leaves 45 billion dollars' worth of money burning in our jeans.

Well, we can do 2 things with this 45 billion dollars. One will make us all poor after the war. The other way will make us decently prosperous.

**This way the 45 billion dollars will make us poor**

If each of us should take his share of this 45 billion dollars (which averages approximately \$330 per person) and hustle out to buy all he could with it—what would happen is what happens at an auction where every farmer there wants a horse that's up for sale.

If we tried to buy all we wanted, we would bid the prices of things up and up and up. Instead of paying \$10 for a dress we're going to pay \$15. Instead of \$5 for a pair of shoes we're going to pay \$8.

This bidding for scarce goods is going to raise prices faster than wages. Wages just won't keep up.

*So what will people do?*

U. S. workers will ask for more money. Since labor is scarce, a lot of them will get it. Then farmers and business men who



feel the pinch are going to ask more money for their goods.

And prices will go *still higher*. And the majority of us will be in that same old spot again—only worse.

This is what is known as Inflation.

Our government is doing a lot of things to keep prices down . . . rationing the scarcest goods, putting ceiling prices on things, stabilizing wages, increasing taxes.



But the government can't do the *whole job*. So let's see what *we* can do about it.

**This way the 45 billion dollars will make us prosperous**

If, instead of running out with our extra

dough, and trying to bid on everything in sight, we buy only what we absolutely need, we will come out all right.

If, for instance, we put this money into (1) Taxes; (2) War Bonds; (3) Paying off old debts; (4) Life Insurance; and (5) The Bank, we don't bid up the prices of goods at all. And if besides doing this we (6) refuse to pay more than the ceiling prices; and (7) ask no more for what we have to sell—no more in wages, no more for goods—*prices stay where they are now*.

And we pile up a bank account. We have our family protected in case we die. We have War Bonds that'll make the down payment on a new house after the war, or help us retire some day. And we don't have taxes after the war that practically strangle us.



Maybe, doing this sounds as if it isn't fun. But being shot at up at the front isn't fun, either. You have a duty to those soldiers as well as to yourself. You *can't* let the money that's burning a hole in your pocket start setting the country on fire.

★ ★ ★

This advertisement, prepared by the War Advertising Council, is contributed by this Magazine in co-operation with the Magazine Publishers of America.

## KEEP PRICES DOWN!

Use it up  
Wear it out  
Make it do  
Or do without



psychological reaction. In addition, the level at which the receiver in the home is operated will determine the extent to which changes in loudness are noticeable, since at low volumes, greater change of intensity is required to be noticeable to the ear than is the case at higher volumes. However, the control man with good taste, a critical ear and keen judgement can strike the "happy medium" between aesthetics and conventional operations. This is of prime importance when voice and music are to be blended as will be discussed later.

(To Be Continued)

## RADIO-ELECTRONIC COMPONENTS

[Continued from page 38]

ing points remain substantially in a straight line. The second type of operation is where the receiver was on for 20 hours and off 4 hours. This is an extreme case; however, it does show the effect of aging components. Note the gradual change in the starting points and the gradual decrease in frequency drift during successive cycles.

Fig. 19 was taken with and without compensation applied to the oscillator tank circuit. The slight "bump" at the start of curve B is due to slow compensation and was reduced in curve C by locating the compensating capacitor at a point where it would reach operating temperature quicker.

Several methods of compensation may be devised by using metals having different coefficients of expansion in the construction of the component parts and taking advantage of this to provide frequency correction. Bimetal has been extensively used to this end.

Curves also show the results of a "long time" frequency drift check. The receiver with treated and stabilized components hardly deviates from the starting point, while the untreated unit is seen to vary from day to day. Incidentally, the curve follows very closely a plot of the daily percent humidity during the test.

(Conclusion)

## VOLUME EXPANSION

[Continued from page 31]

An interesting characteristic of this circuit eliminates the need of delay voltage often required in the conventional expander of Fig. 1-B. Since the portion of  $e_s$  applied to the grid of  $T_2$  increases while the  $\mu$  of  $T_2$  is decreasing, there is a small range where normal compression is effected. This range is at comparatively low volume levels and expansion does not occur to



*new methods  
new techniques*

Pearl Harbor's first challenge was to American Industry. In the answer to that challenge lay the difference between victory and defeat. It was found largely in increased efficiency, new methods, new techniques. More bombers with fewer man hours . . . More VIKING radio transmitting parts per man and machine. The big bouquet for this job goes to the production men, the methods engineers, the works superintendents, the foremen and those like them.

We are proud of such men in our organization. They've given us new tube sockets, condensers, and many other parts quickly the way they were needed. Their new methods, and techniques (not least among them the highly perfected art of large scale high speed Mycalex fabrication) have enabled us to quadruple our pre-Pearl Harbor production despite the contribution of many of our male employees to the services.

We're making more parts better, thanks to much improved production techniques, and we're proud of the part we've been permitted to play in answering civilization's greatest challenge. When the smoke of Victory has cleared Johnny Doughboy, we'll march back to new life, in which such things as improved Johnson electronic equipment will contribute to the happier world he so richly deserves.

WRITE FOR GENERAL  
PRODUCTS CATALOG  
967K



**JOHNSON**  
*a famous name in Radio*

E. F. JOHNSON COMPANY  
W A S E C A , M I N N E S O T A

a marked extent at varying, low signal voltages. However, as the input signal amplitude increases above this point, the  $\mu$  of  $T_2$  becomes the controlling factor in determining the value of  $c\beta$ , and normal expansion results.

Capacitor  $C_6$  and the resistor  $R_7$ , together with portion  $a$  of control  $R_4$  determine the time constant for expansion. The values listed in the schematic diagram, used by the author, provide a time constant of 0.125 second minimum. This value was found satisfactory for radio and phonographic use.

The value of the resistor  $R_7$  has not

been listed. This resistor will have a value dependent on the type of phonograph pickup used as well as the type of needle employed. For example, with an Astatic type AB-8 pickup, and a good quality fibre needle,  $R_7$  could be eliminated from the circuit; with the same pickup using a steel or jewel needle, the value of  $R_7$  should be at least one megohm. The shunting impedance of the expander circuit should be taken into consideration when adjusting the pickup load.

Referring to equation 5, it is readily seen that the degree of expansion is controlled by the value of  $c\beta$ . If a

large degree of dynamic response is desired,  $e\beta$  will have to be comparatively great. Consequently the control  $R_6$  together with the constants  $R_7$ ,  $R_{14}$ , and  $R_{18}$  are the controlling factors in determining the amount of expansion.

The method for mixing  $c_s$  and  $e\beta$  used by the author is shown in Fig. 3-B. The only reason that this type of mixing was used was the fact that the first audio stage of the amplifier for which the expander unit was designed employed a 6J7 pentode. The signal voltage  $e\beta$  is applied to the screen of the 6J7 by means of the voltage-divider circuit  $R_{14}$  and  $R_{18}$  and the capacitors  $C_{10}$  and  $C_{12}$ . This method has proved satisfactory, with no trouble caused by phase shift. Other types of mixer circuits would undoubtedly operate as well; for example, had a triode of the 6C5 or 6J5 type been used in the first audio stage, a mixer circuit using a dual triode of the 6F8 or 6SN7 variety could be employed.

#### Expander Adjustment

Adjustment of the expander may be done by ear. Referring to Figs. 3-A and 3-B, set controls  $R_4$ ,  $R_6$ , and  $R_{16}$  at ground potential. Now apply a signal voltage,  $c_s$ , by means of a phonograph record and turn  $R_6$  until a comparatively small signal is heard in the speaker output; this signal represents  $c\beta$ . Adjust  $R_4$  until plate-current cut-off is reached by  $T_2$  on loud musical passages (the signal in the speaker will fade out). Finally turn the master gain control  $R_{16}$  through the zero-signal point, (effective  $c_s = \text{effective } c\beta$ ) to setting of maximum volume for loud musical passages. If after these first adjustments the soft passages are too quiet, reset  $R_6$  nearer ground potential reducing the magnitude of  $c\beta$ . The proper setting of the controls may be found with but little trouble.

Should it be desired to use the expander circuit under fixed conditions of pickup, stylus, etc., a variable resistor may be inserted in series with the master control  $R_{16}$ , at the ground end. With  $R_{16}$  set at its low-potential end, the series resistor may be adjusted in place of  $R_{16}$  as described in the previous paragraph, except that the series resistor should be set so that the effective  $c\beta$  is always less than the effective  $c_s$  for any setting of the control  $R_{16}$ . That is to say, zero signal is never reached, even on soft musical passages, with  $R_{16}$  at the "off" position, but is always above the zero-signal point.

#### Advantages of Circuit

The distortion inherent in the conventional volume expander on large input signals is eliminated in this type of expander circuit. Since, as the sig-



## IMPROVED low loss Align-Aire Trimmer!

Meissner improved, low loss, low drift, Align-Aire Trimmers are ideally suited for operation under high humidity...and in critical R.F. circuits... 3200 degrees rotation... less than 1 mmf per 180 degrees!

Dissipation factor at 1000 kc: .064%...  
Q-1570... dissipation factor at 40 mc: 3.7%... insulation resistance: greater than 1500 megohms... breakdown over 350 volts, 60 cycles... 700 volt AC breakdown available on special order. Meissner Align-Aires are encased in the newly developed Type 16444 Bakelite... compact in size:  $\frac{7}{16}$ " in diameter by  $1\frac{1}{8}$ " long. Samples sent upon request.

**Meissner**

MT. CARMEL, ILLINOIS

"PRECISION-BUILT ELECTRONIC PRODUCTS"





nal input increases the plate current of  $T_2$  approaches cut-off,  $c\beta$  will become ineffective and distortion cannot occur. Should there be any distortion caused by  $T_2$  at low signal levels, this distortion would tend to be cancelled out in the mixer in a manner similar to that in negative feedback amplifiers.

An outstanding advantage of this circuit is the ability to effect bass or treble boosting at low volume levels, thus providing a convenient method of automatic tone control. If a small capacitor is placed from grid 1 of  $T_2$  to ground, high-frequency audio components will be eliminated from  $c\beta$  and thus effect boosting of these higher frequencies at low volume levels. A resistance-capacitance arrangement may be used to obtain the desired frequency attenuation.

When treble accentuation is required this method of low-level boosting is most valuable. In an amplifier where the output stage employs power pentodes or beam power tubes the plate load impedance will increase directly with frequency if an ordinary output transformer is used. With conventional methods of high-frequency boosting the amount of compensation is constant for all values of the input signal voltages. At high volume levels this gives rise to very noticeable frequency distortion. With decreased boosting at larger input signal strength as effected by this expander circuit, the frequency distortion can be no greater than that of the amplifier.

For treble boosting it is necessary to have a value of  $R_x$  much greater than zero. Were  $R_x$  equal to zero and  $R_6$  set in maximum position, then a capacitor from the grid of  $T_2$  to ground would directly shunt the pickup load, resulting in the attenuation of the high audio frequencies in the input circuit of  $T_3$  and boosting could not be effected. However, with  $R_x$  equal to one megohm as is the usual case, this shunting is avoided and treble boosting is accomplished.

Low-level bass boosting may likewise be effected, thereby partially compensating for the deficiencies of the ear at low volume levels. For example, the capacitor  $C_5$  may be chosen so that its reactance at low audio frequencies is large compared to the value of  $R_9$ . If boosting is required at 150 cycles and lower, and using the circuit values suggested,  $C_5$  may be made  $0.005 \mu\text{f}$  instead of the stated value of  $0.01 \mu\text{f}$ . If sharper low-frequency attenuation in  $c\beta$  is desired,  $C_{10}$  may also be appropriately changed. Here a word of caution: if too great a degree of low-frequency compensation is attempted, a point may be reached where regeneration, caused by an excessive phase shift, may result.

### With Radio Input

The advantages of the circuit have already been enumerated so that little is left to say in conclusion. However, two facts should be mentioned. Throughout this article the application of the expander has been primarily associated with phonographic use; its application to radio receivers is equally of merit, especially in respect to low volume level tone compensation for symphonic broadcasts. The second point which should be brought to the reader's attention is that no change in fundamental amplifier design is necessary aside from the screen circuit of

the input (mixer) tube; for example, with good design negative feedback voltage may be brought back from the output stage to the cathode or even screen of the input tube without consequent regenerative oscillations.

### STUDY GUIDE

[Continued from page 41]

der optimum operating conditions in the single-ended amplifier.

It is also apparent from Fig. 2 that the zero-signal plate currents  $I_{b_0}$  of the two tubes flow in opposite directions in

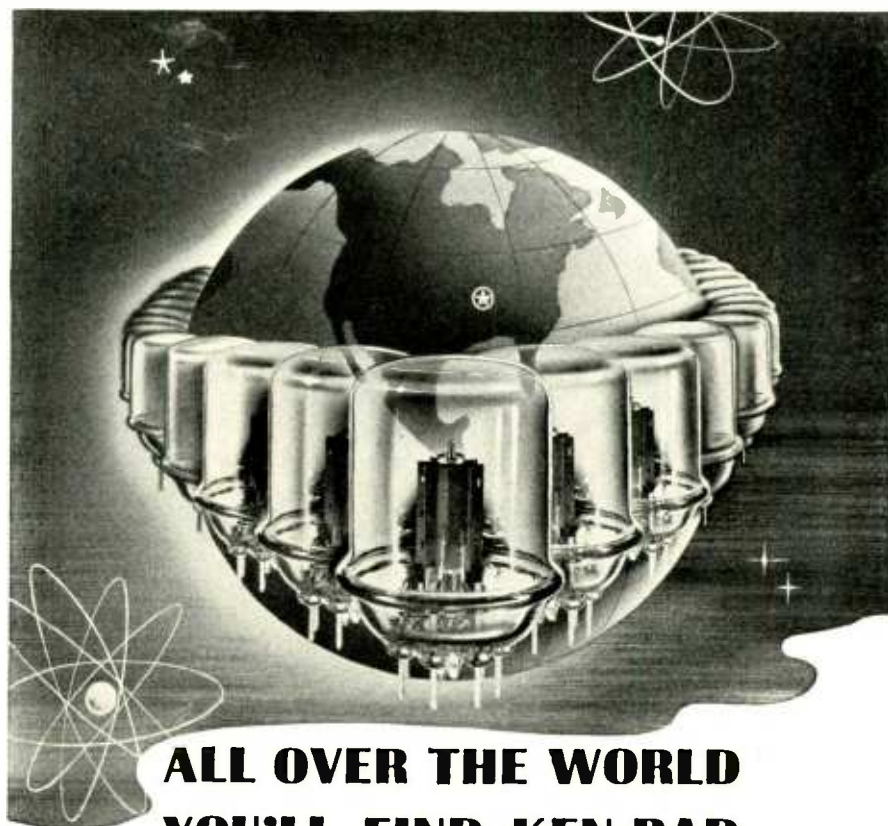

## ALL OVER THE WORLD YOU'LL FIND KEN-RAD

All over the embattled world Ken-Rad tubes help to make our victory certain and complete

Not until victory can the story be released  
Then it will merge with the headlines of electronic triumphs in the worlds of tomorrow

Industry will then utilize the electronic developments of the war to produce for better living

# KEN-RAD

TRANSMITTING TUBES  
CATHODE RAY TUBES

SPECIAL PURPOSE TUBES  
METAL AND VHF TUBES

INCANDESCENT LAMPS  
FLUORESCENT LAMPS

OWENSBORO KENTUCKY U S A

**RADIO**

\* AUGUST, 1943

61

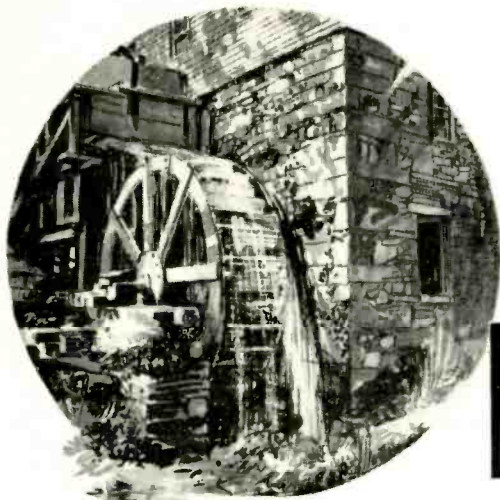

## 'Round and 'Round We Go..

● Day in and day out, Astatic's manufacturing facilities are devoted in large part to the production of Constant Impedance High Frequency Connectors, Co-axial Cable Connectors and Multi-contact Plugs and Sockets for electronic equipment. All energies are devoted to maintaining production standards to bring victory closer. For those industries with high priority ratings, Astatic continues to manufacture a limited number of Microphones and Phonograph Pickups for which Astatic is so widely known.

**ASTATIC**

IN CANADA:  
CANADIAN ASTATIC, LTD.  
TORONTO, ONTARIO

**THE ASTATIC CORPORATION**  
YOUNGSTOWN, OHIO

## BUD PRECISION CONDENSERS

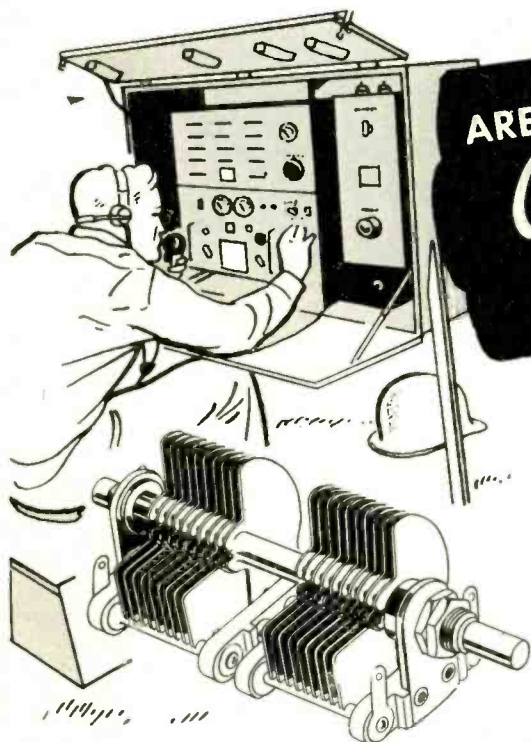

ARE PROVING THEY  
*Can Take It!*

In war zones where communications equipment is really taking a pounding, BUD precision condensers and other BUD parts are proving their real worth under fire. After the war you will be even more sure that BUD precision parts will give you the dependability you need.

**BUD**

**BUD RADIO, INC.**

CLEVELAND, OHIO

the two halves of the primary. The net magnetization of the core resulting from these two currents is zero. This is another outstanding advantage of the push-pull amplifier. For a given power output and distortion, the push-pull transformer is smaller and less expensive than the single-ended transformer. It is not necessary to use a large core with an air gap to prevent direct-current magnetization of the core. Waveform distortion due to non-linear characteristics of the transformer is reduced and the low frequency response is improved.

In ideal operation, in which the individual tubes produce no second-harmonic distortion, the sum of the instantaneous plate currents in the two tubes is a constant ( $2I_{b0}$ ). In practice this condition exists when the signal is small compared to the bias voltage. The power supply is required to deliver a constant current and therefore it is not necessary to use a well-regulated supply with low internal impedance. For the same reason the common bias resistor used in self-bias operation need not be by-passed by a capacitance. However, it is highly desirable to include this capacitance since the ideal mode of operation does not exist except for small signals.

Fig. 3 illustrates the graphical analysis for Class A push-pull operation. Two sets of  $i_b$ - $e_b$  statics are placed together in the manner indicated, making the  $E_b$  points to coincide. The composite statics are drawn by adding the instantaneous values of the plate currents in the two tubes along a common ordinate. The path of operation or dynamic load line of the individual tube represents the instantaneous values of plate-current and plate-voltage for a single tube.

### Class B Amplifiers

31. Describe the characteristics of a vacuum tube operating as a Class B amplifier. (II-137)

32. During what portion of the excitation voltage cycle does plate current flow when a tube is used as a Class B amplifier? (II-138)

33. Why is it necessary to use two tubes in Class B audio amplification? (V-153)

34. Why does a Class B audio-frequency amplifier stage require considerably greater driving power than a Class A amplifier? (III-165)

35. Discuss the input circuit requirements for a Class B audio-frequency amplifier grid circuit. (III-166)

36. Why are Class A audio amplifiers not as critical, insofar as grid-drive requirements are concerned, as Class B audio amplifiers? (V-160)

The plate-current waves in Fig. 3 indicate that it is possible to obtain a



symmetrical load curve wave with plate current flowing for only 180 degrees of each cycle in the individual tubes. This mode of operation, known as Class B, can be obtained by the use of a higher bias; namely, cut-off bias. It is further apparent that no serious increase in plate circuit distortion will result if the grids are driven positive. These two changes permit the use of a greater signal and result in more power output.

The high zero-signal plate current  $I_{b0}$  in Class A operation results in a considerable loss of power in the form of plate dissipation. Maximum theoretical efficiency for Class A operation is 50%; in practice 20% is considered good operation. Maximum theoretical efficiency for Class B operation is 78.5%; in practice 60% is considered good operation. These factors indicate that for a given consumption of d.c. power a Class B circuit will deliver six times as much audio power as a Class A circuit. This is a very important matter in the operation of the audio amplifier used to modulate the final Class C stage of a 50-kw broadcast transmitter. If we assume the Class C stage to operate with an efficiency of 65%, the d.c. power input is 77 kw. It would require an audio amplifier with an output of 38.5 kw to modulate the Class C stage 100%. With a Class A modulator the d.c. power consumption

would be 192 kw; with a Class B modulator the d.c. power consumption would be 64 kw. This difference would amount to 76,800 kw-hr for a 30-day month of 20-hr days and hardly leaves any doubt about the use of a Class B circuit in a high-power modulator.

Two new problems arise in the use of the Class B audio amplifier. The zero-signal plate current for each tube is approximately zero. The magnitude of the plate current varies with the signal. Hence the power supply is required to deliver constant voltage with a widely fluctuating plate current. This calls for a supply with especially small voltage regulation or internal resistance. Again, because of the fluctuating plate current it is not possible to obtain bias from a resistor in the cathode circuit. A fixed grid bias voltage from a low-impedance source is required. To simplify this problem, special tubes known as 'zero-bias tubes' have been designed for low-power class B audio amplifiers.

The second problem results from the fact that grid current flows during a portion of the cycle. In the Class A power amplifier the grids are driven by a voltage amplifier. In the Class B power amplifier the grid must be supplied power from a power amplifier. The grid driving power increases with grid current and the amplitude of the



Manufacturers  
of Component parts for  
the Radio, Electronic  
and Communications  
Industries . . . . .

THE MUTER CO.  
1255 South Michigan Avenue  
Chicago, U. S. A.

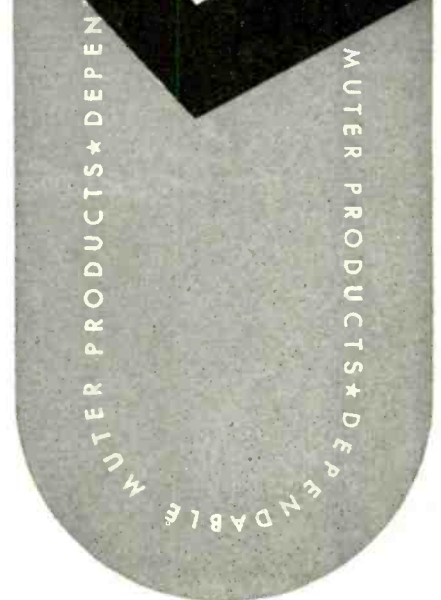

# The Sun Never Sets on a CINAUDAGRAPH SPEAKER

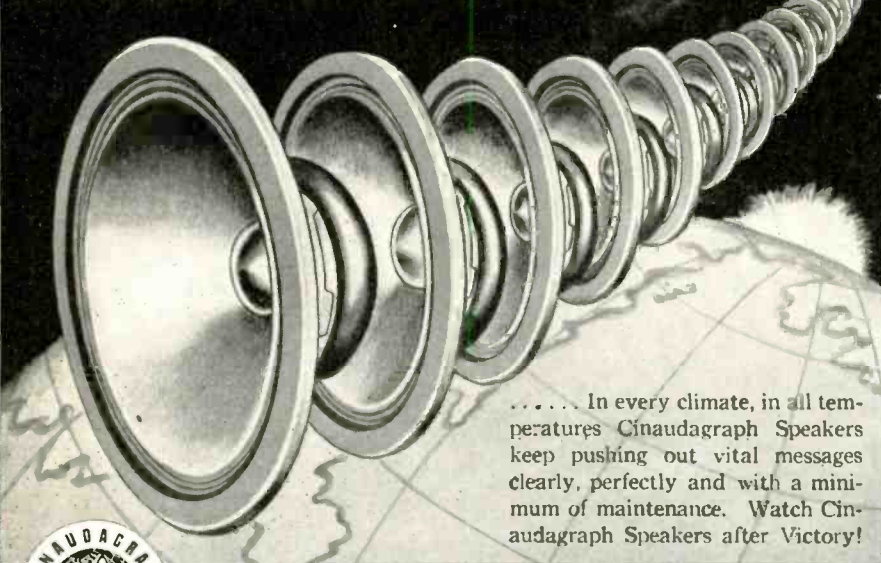

..... In every climate, in all temperatures Cinaudagraph Speakers keep pushing out vital messages clearly, perfectly and with a minimum of maintenance. Watch Cinaudagraph Speakers after Victory!



**Cinaudagraph Speakers, Inc.**

3911 S. Michigan Ave., Chicago

*"No Finer Speaker Made in all the World"*

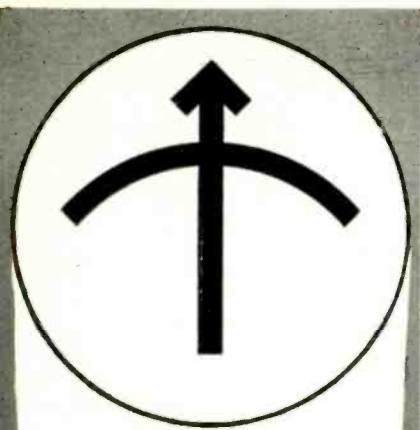

# LABORATORY STANDARDS

- Standard Signal Generators
- 
- Square Wave Generators
- 
- Vacuum Tube Voltmeters
- 
- U. H. F. Noisemeters
- 
- Pulse Generators
- 
- Moisture Meters
- 

## MEASUREMENTS CORPORATION

Boonton, New Jersey

signal voltage. To prevent excessive grid circuit distortion, the impedance looking back to the driver stage from the grid-cathode terminals of the Class B stage must be considerably less than the impedance looking into the Class B stage from the same terminals. This calls for a low-impedance driver tube, usually a triode, and a coupling transformer with a step-down impedance ratio.

From the problems considered here, it is apparent that the design of the Class B audio amplifier is more critical than that of the Class A circuit. High-level audio amplifiers used as modulators are probably the most common application of the Class B audio amplifier.

### TECHNICANA

[Continued from page 42]

$$F = (R + S)/Sx \quad (1)$$

"If the instrument *M* is disconnected at the points *X* and *X'* (Fig. 5) and the circuit arrangement of Fig. 6 substituted, with the switch *K* in position 1, the current giving full-scale deflection of *M* will be determined by the current range selected with switch *A*. If *K* is put in position 2 any of the current ranges selected by *A* will be mul-

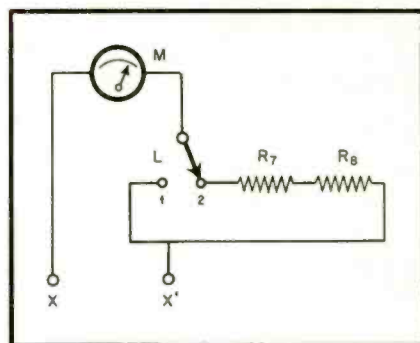

Fig. 7. Revised switch circuit.

tiplied by a factor *F'* such that

$$F' = R/R_1 + 1 \quad (2)$$

*R*2 must satisfy the equation

$$R_2 = R - \frac{R_1 R}{R_1 + R} = R - \frac{R}{F'} = \frac{R(F' - 1)}{F'} \quad (3)$$

while *R*1 is given from equation (2) as

$$R_1 = \frac{R}{F' - 1} \quad (4)$$

"If instead of the circuit arrangement of Fig. 6 the circuit of Fig. 7 is connected between the points *X* and *X'* in Fig. 5, with switch *L* in position 1, the current required for full-scale deflection of the instrument *M* will be

## METAL Stampings

### DUPLICATED WITHOUT DIES

If you desire to save time and critical materials on production of metal stampings or other small parts, then the DI-ACRO System of "Metal Duplicating Without Dies" merits your consideration. It is based on the rapid and accurate production of formed parts with DI-ACRO Shears, Brakes and Benders. All duplicated work is accurate to .001". These precision machines are adaptable to an endless variety of work, and ideally suited for use by girl operators. For short runs your parts are processed in a matter of hours instead of waiting weeks for dies.

SHEARS

BRAKES

BENDERS

Send for this Catalog  
"METAL DUPLICATING WITHOUT DIES"

It illustrates many stampings or parts made without dies, gives full details on DI-ACRO machines and shows how they may readily be adapted for various applications. Request your copy now.



**O'NEIL-IRWIN DI-ACRO MFG. CO.** 346 Eighth Ave. So. Minneapolis 15, Minn.



# WEST COAST RADIO AND ELECTRONIC BOOKS HEADQUARTERS

For the convenience of our western friends, we maintain a small stock of those hard-to-get radio and electronic books.

Mail orders handled at publishers' prices plus 4% for postage; in California, add 2½% sales tax. Telephone inquiries welcomed; our number is Hillside 3429.

## EDITORS AND ENGINEERS, Ltd.

Publishers of the  
"RADIO HANDBOOK"

1422 N. Highland Ave.  
Los Angeles 28

determined by the current range selected with switch *A*. If *L* is put in position 2 any of the current ranges selected by *A* will be multiplied by a factor

$$F'' = \frac{R_7 + R_8}{R + S} + 1 \quad (5)$$

from which

$$R_7 + R_8 = (F'' - 1) \cdot (R + S) \quad (6)$$

follows."

By the combination of the three circuits shown it is possible to obtain a multiplicity of ranges with a reduced number of resistors. The switches *A*, *K* and *L* are all placed so that their contact resistances are of little effect since *A* is in the line circuit and *K* and *L* are in series with the meter where *R* is large with respect to the contact resistance. The article shows a complete circuit for an instrument having 38 ranges using but 14 resistors.

### NEW PRODUCTS

[Continued from page 54]

One of the new outstanding features of Whitex is that it is moisture resistant on both sides. Draftsmen know the importance of this feature to guard against spots from perspiration or moist hands. Too often these spots show up to mar the prints from the finished drawing.

This feature plus the glass-like transparency of Whitex assures prints that are etching sharp.

Samples of this new white pencil tracing cloth can be secured by writing The Frederick Post Company, Box 803, Chicago.

### THIS MONTH

[Continued from page 52]

Dobbs Ferry, N. Y., announces a new trademark "Norelco," which will now be applied to products handled by its Industrial Electronics Division at 419 Fourth Avenue, New York.

These products will include electronic temperature indicators; direct reading frequency meters; Searchray (industrial and research X-ray) apparatus; X-ray quartz crystal analysis apparatus and other electronic applications.

The "Norelco" trademark will also cover cathode-ray tubes; transmitter, amplifier and rectifier tubes; quartz oscillator plates; fine wire of all drawable metals; bare, plated and enameled, and diamond dies, all of which will continue to be handled direct from the Dobbs Ferry plant.

## Space Saver OIL CAPACITOR with the NEW double terminals



● Something new has been added to this long-popular Aerovox Type '10 Hyvol capacitor. Note the double terminals on the stepped bakelite threaded terminal post. This means the can of this handy inverted-screw-mounting capacitor is now insulated or "floating". No longer is an insulator washer required when non-grounded mounting on a metal chassis is desired.

As handy to install as the usual metal-can electrolytic. And just as compact. 600 to 1500 v. D.C.W. .5 to 4 mfd.

● New Aerovox Capacitor Catalog just out. Write on business stationery for your copy, if you are engaged in professional radio or electronics work.



AERVOX CORP., NEW BEDFORD, MASS., U. S. A.  
In Canada: AERVOX CANADA LTD., HAMILTON, ONT.  
Export: 100 VARICK ST., N. Y. C. • Cable: 'ARLAB'

**TODAY—**  
*is the time to*  
**turn your RADIO JOB**  
*into a SECURE POSITION!*

Do you want a **BETTER JOB—a SECURE FUTURE?** Now is the time to prepare yourself for a lasting, profitable career in radio and industrial electronics. The good jobs—the *permanent positions* in radio don't come easy. The sure way to success is to build your future on a sound foundation of *knowledge and ability*—and the ability that you develop now is your assurance of a steady, sure income that will outlast the temporary conditions that exist today. CREI technical home study training is designed to do *just one thing—to increase your ability*, enabling you to hold the more responsible positions which lead to higher salaries.

**Write for Details**  
 About CREI Home Study Courses  
*If you are a professional or amateur radioman and want to make more money—let us prove to you we have something you need to qualify for the BETTER career-job opportunities that can be yours. To help us intelligently answer your inquiry—*  
**PLEASE STATE BRIEFLY YOUR EDUCATION, RADIO EXPERIENCE AND PRESENT POSITION.**



Free Booklet Sent

**CAPITOL RADIO ENGINEERING INSTITUTE**  
 Dept. RA-8, 3224-16th St., N.W., Washington 10, D. C.

**Subscribers—**  
**ARE YOU MOVING?**



Due to the shortage of manpower, more time is required for the handling of changes of address and the making of new stencils. If you change residence, please make every effort to provide us with your new address from two to three weeks before you move. The Post Office Department does not forward magazines mailed to a wrong address unless you pay additional postage; and we cannot duplicate copies mailed to old addresses. Your cooperation will be appreciated.

Subscription Department

**RADIO MAGAZINES, NC.,**  
 132 W. 43rd St., New York 18, N. Y.

**APOLOGY TO LINK**

★ The photo used on the front cover of our July issue was credited exclusively to the duPont Co., makers of Lucite. Since the parts shown in the photo are the products of Fred M. Link, Engineer-Manufacturer, credit should have been given this company. Sorry.

The "Elmet" trademark will continue to be used in connection with tungsten and molybdenum in powder, rod, wire and sheet form as well as tungsten alloys made by the company in its factory at Lewiston, Maine.

An associated company—Philips Metalix Corporation, Mount Vernon, N. Y., is handling Philips X-ray medical apparatus through its New York office, 419 Fourth Avenue.

The productive activity of North American Philips Company, Inc., is still concentrated on war work.



**ZENITH PLAN SAVES GOVERNMENT MILLIONS**

The government is saving incalculable millions of dollars in royalty payments on radio patents as the result of a plan proposed to the Signal Corps in 1941 by Commander E. F. McDonald, Jr., president of Zenith Radio Corporation, of Chicago. Under this plan, which has been accepted by all but three or four of the country's manufacturers of radionic equipment, each company has granted the government a free license for the duration of the war under all patents it owns or controls.

The story was released by Hugh Robertson, executive vice-president and treasurer of the company, who recently received two government checks for one dollar each as payment in full for royalties on patents of Zenith and its wholly owned subsidiary, the Wincharger Corporation, of Sioux City, Iowa, which owns numerous patents on motor generating equipment used in tanks and airplanes.



**NEW UNIVERSAL CATALOG**

Universal Microphone Co., Inglewood, Cal., under the caption of "Universal U. S. Army and Navy Specification Plugs and Jacks," has issued a 9"x11" loose-leaf size four-page edition of its Catalog No. 830.

Besides plugs and jacks, the illustrated catalog includes descriptions of prongs, cord clamps, jack inserts and shells for both jacks and plugs.

Universal will shortly publish a new issue of its general microphone catalog.



**BURSTEIN-APPLEBEE CO.**  
 1012-14 McGee St. Kansas City, Mo.

**ADVERTISING INDEX**

Aerovox Corp.	65
American Automatic Elec. Sales Co.	13
Andrew Co., Victor J.	12
Astatic Corp., The	62
Bliley Electric Co.	57
Bud Radio, Inc.	62
Burstein-Applebee Co.	66
Capitol Radio Eng. Inst.	66
Centralab	51
Cinaudagraph Speakers, Inc.	63
Connecticut Tel. & Elec. Div.	19
Crystal Products Co.	5
Echophone Radio Co.	45
Editors & Engineers	65
Eitel-McCullough, Inc.	53
Electronic Corp. of America	9
Galvin Mfg. Corp.	14
General Electronic Industries, Division of Auto-Ordnance Corp.	15
Guardian Electric Co.	11
Guthman & Co., Inc., Edwin I.	7
Hallcrafters Co., The	3, 4
Hytron Corporation	Cover 4
Jensen Radio Mfg. Co.	22
Johnson Co., E. F.	59
Ken-Rad Tube & Lamp Corp.	61
Lafayette Radio Corp.	55
Measurements Corp.	64
Meck Industries, John	Cover 3
Meissner Mfg. Co.	60
Muter Co., The	63
O'Neil-Irwin Mfg. Co.	64
Pioneer Gen-E-Motor	56
Racon Electric Co.	49
Raytheon Mfg. Co.	Cover 2
RCA Mfg. Co., Inc.	10
Rola Co., Inc.	47
Scientific Radio Prods. Co.	20
Triplett Elec. Inst. Co.	16
Universal Microphone Co.	21
Utah Radio Products Co.	18
War Advertising Council	58
Wilcox Electric Co., Inc.	17



# CRYSTALS

*This is Plymouth*

*Three Three*

*Front Line Action on  
your Crystal Problems*

With our war-expanded facilities and equipment it's no chore at all to produce, also, special crystal types, to any temperature coefficient and absolute frequency specifications, for less spectacular but highly important civilian needs — in small or large quantities. Just speak to our

PHONE CRYSTAL SERVICE DIVISION  
PLYMOUTH (INDIANA) THREE THREE



**JOHN MECK INDUSTRIES**  
**PLYMOUTH, INDIANA**



# ONE *Expert* TO SEND THE MESSAGE

Miss Gertrude Theberge records results of 955 ultra-high-frequency performance tests.

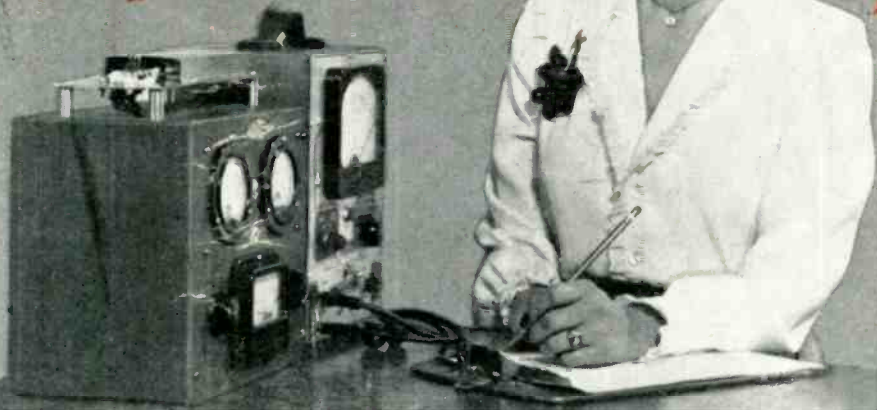

# ONE *Expert* TO PROVIDE THE EQUIPMENT

Specialists on the Factory Front must back up those on the Fighting Front. As an American, you would be proud to see at Hytron carefully trained girls holding down important supervisory and technical jobs, and displaying manual dexterity on fine work which a watchmaker would admire.

Here at Hytron we realize fully our responsibility for fashioning well the radar, radio, and electronic tubes upon whose performance the lives of our fighting men depend. To fulfill this trust, we have gone all out to train hundreds of new specialists capable of building to exacting standards countless dependable War tubes. That their skills may help bring closer the day when our boys come marching home, is the sole purpose of all Hytron employees.



VR105-30 and VR150-30  
Gaseous voltage-regulator tubes

*Oldest Exclusive Manufacturer of Radio Receiving Tubes*

# Hytron

ELECTRONIC AND  
RADIO TUBES

# Corporation

SALEM AND NEWBURYPORT, MASS.

